

Blu-ray Disc™ / DVD Player

Operating Instructions

Thank you for your purchase. Before using this player, please read these instruction carefully.

Getting Started

Playback

Settings and Adjustments

Additional Information



WARNING

To reduce the risk of fire or electric shock, do not expose this appliance to dripping or splashing, and do not place objects filled with liquids, such as vases, on the appliance.

To avoid electrical shock, do not open the cabinet. Refer servicing to qualified personnel only.

The mains lead must be changed only at a qualified service shop.

Do not expose batteries or appliances with battery-installed to excessive heat, such as sunshine and fire.

CAUTION

The use of optical instruments with this product will increase eye hazard. As the laser beam used in this Blu-ray Disc/DVD player is harmful to eyes, do not attempt to disassemble the cabinet. Refer servicing to qualified personnel only.





This label is located on the laser protective housing inside the enclosure.



This appliance is classified as a CLASS 1 LASER product. The CLASS 1 LASER PRODUCT MARKING is located on the rear exterior.

Notice for customers in the United Kingdom and Republic of Ireland

A molded plug complying with BS1363 is fitted to this equipment for your safety and convenience.

Should the fuse in the plug supplied need to be replaced, a fuse of the same rating as the supplied one and approved by ASTA or BSI to BS1362, (i.e., marked with  or  mark) must be used. If the plug supplied with this equipment has a detachable fuse cover, be sure to attach the fuse cover after you change the fuse. Never use the plug without the fuse cover. If you should lose the fuse cover, please contact your nearest Sony service station.



Disposal of Old Electrical & Electronic Equipment (Applicable in the European Union and other European countries with separate collection systems)

This symbol on the product or on its packaging indicates that this product shall not be treated as household waste. Instead it shall be handed over to the applicable collection point for the recycling of electrical and electronic equipment. By ensuring this product is disposed of correctly, you will help prevent potential negative consequences for the environment and human health, which could otherwise be caused by inappropriate waste handling of this product. The recycling of materials will help to conserve natural resources. For more detailed information about recycling of this product, please contact your local Civic Office, your household waste disposal service or the shop where you purchased the product.



Disposal of waste batteries (applicable in the European Union and other European countries with separate collection systems)

This symbol on the battery or on the packaging indicates that the battery provided with this product shall not be treated as household waste. On certain batteries this symbol might be used in combination with a chemical symbol. The chemical symbols for mercury (Hg) or lead (Pb) are added if the battery contains more than 0.0005% mercury or 0.004% lead. By ensuring these batteries are disposed of correctly, you will help prevent potentially negative consequences for the environment and human health which could otherwise be caused by inappropriate waste handling of the battery. The recycling of the materials will help to conserve natural resources.

In case of products that for safety, performance or data integrity reasons require a permanent connection with an incorporated battery, this battery should be replaced by qualified service staff only.

To ensure that the battery will be treated properly, hand over the product at end-of-life to the applicable collection point for the recycling of electrical and electronic equipment.

For all other batteries, please view the section on how to remove the battery from the product safely. Hand the battery over to the applicable collection point for the recycling of waste batteries.

For more detailed information about recycling of this product or battery, please contact your local Civic Office, your household waste disposal service or the shop where you purchased the product.

This product has been manufactured by or on behalf of Sony Corporation, 1-7-1 Konan Minato-ku Tokyo, 108-0075 Japan. Inquiries related to product compliance based on European Union legislation shall be addressed to the authorized representative, Sony Belgium, bijkantoor van Sony Europe Limited, Da Vincilaan 7-D1, 1935 Zaventem, Belgium. For any service or guarantee matters, please refer to the addresses provided in the separate service or guarantee documents.

Precautions

- The nameplate is located on the bottom of the unit.
- This unit operates on 220 V - 240 V AC, 50/60 Hz. Check that the unit's operating voltage is identical with your local power supply.
- Install this unit so that the mains lead can be unplugged from the wall socket immediately in the event of trouble.

Notice for the customers in Europe (BDP-S3700 only)



Hereby, Sony Corporation declares that this equipment is in compliance with Directive 2014/53/EU.

The full text of the EU declaration of conformity is available at the following internet address:

<http://www.compliance.sony.de/>

Precautions

This equipment has been tested and found to comply with the limits set out in the EMC Directive using a connection cable shorter than 3 metres.

On placement

- Place the player in a location with adequate ventilation to prevent heat build-up in the player.
- To reduce the risk of fire, do not cover the ventilation opening of the appliance with newspapers, tablecloths, curtains, etc.
- Do not expose the appliance to naked flame sources (for example, lighted candles).
- Do not install this player in a confined space, such as a bookshelf or similar unit.
- Do not place the player outdoors, in vehicles, on ships, or on other vessels.
- If the player is brought directly from a cold to a warm location, or is placed in a very damp room, moisture may condense on the lenses inside the player. Should this occur, the player may not operate properly. In this case, remove the disc and leave the player turned on for about half an hour until the moisture evaporates.
- Do not install the player in an inclined position. It is designed to be operated in a horizontal position only.
- Do not place metal objects in front of the front panel. It may limit reception of radio waves.
- Do not place the player in a place where medical equipment is in use. It may cause a malfunction of medical instruments.
- If you use a pacemaker or other medical device, consult your physician or the manufacturer of your medical device before using the wireless LAN function.
- This player should be installed and operated with a minimum distance of at least 20 cm or more between the player and a person's body (excluding extremities: hands, wrists, feet and ankles).

- Do not place heavy or unstable objects on the player.
- Do not place any objects other than discs on the disc tray. Doing so may cause damage to the player or the object.
- Take out any discs from the tray when you move the player. If you don't, the disc may be damaged.
- Disconnect the AC power cord (mains lead) and all other cables from the player when you move the player.

On power sources

- The player is not disconnected from the AC power source (mains) as long as it is connected to the wall outlet, even if the player itself has been turned off.
- Disconnect the player from the wall outlet if you are not going to use the player for a long time. To disconnect the AC power cord (mains lead), grasp the plug itself; never pull the cord.
- Observe following points to prevent the AC power cord (mains lead) being damaged. Do not use the AC power cord (mains lead) if it is damaged, as doing so may result in an electric shock or fire.
 - Do not pinch the AC power cord (mains lead) between the player and wall, shelf, etc.
 - Do not put anything heavy on the AC power cord (mains lead) or pull on the AC power cord (mains lead) itself.

On AC adaptor

- Use the supplied AC adaptor for this player, as other adaptors may cause a malfunction.
- Do not disassemble or reverse-engineer.
- Do not confine the AC adaptor in a closed place such as a bookshelf or an AV cabinet.
- Do not connect the AC adaptor to a traveler's electric transformer, which may generate heat and cause a malfunction.
- Do not drop or apply shock.

On adjusting volume

Do not turn up the volume while listening to a section with very low level inputs or no audio signals. Your ears and the speakers may be damaged when the sound level reaches the peak.

On cleaning

Clean the cabinet, panel, and controls with a soft cloth. Do not use any type of abrasive pad, scouring powder or solvent such as alcohol or benzene.

On cleaning discs, disc/lens cleaners

Do not use cleaning discs or disc/lens cleaners (including wet or spray types). These may cause the apparatus to malfunction.

On replacement of parts

In the events that this player is repaired, repaired parts may be collected for reuse or recycling purposes.

On connecting to the HDMI OUT jack

Observe the following as improper handling may damage the HDMI OUT jack and the connector.

- Carefully align the HDMI OUT jack on the rear of the player and the HDMI connector by checking their shapes. Make sure the connector is not upside down or tilted.

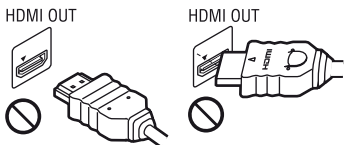

- Be sure to disconnect the HDMI cable when moving the player.



- Hold the HDMI connector straight when connecting or disconnecting the HDMI cable. Do not twist or force the HDMI connector into the HDMI OUT jack.

IMPORTANT NOTICE

Caution: This player is capable of holding a still video image or on-screen display image on your television screen indefinitely. If you leave the still video image or on-screen display image displayed on your TV for an extended period of time you risk permanent damage to your television screen. Plasma display panel televisions and projection televisions are susceptible to this.

If you have any questions or problems concerning your player, please consult your nearest Sony dealer.

Copy Protection

Please be advised of the advanced content protection systems used in both Blu-ray Disc™ and DVD media. These systems, called AACS (Advanced Access Content System) and CSS (Content Scramble System), may contain some restrictions on playback, analogue output, and other similar features. The operation of this product and the restrictions placed may vary depending on the date of purchase, as the governing board of the AACS may adopt or change its restriction rules after the time of purchase.

Cinavia Notice

This product uses Cinavia technology to limit the use of unauthorized copies of some commercially-produced film and videos and their soundtracks. When a prohibited use of an unauthorized copy is detected, a message will be displayed and playback or copying will be interrupted.

More information about Cinavia technology is provided at the Cinavia Online Consumer Information Center at <http://www.cinavia.com>. To request additional information about Cinavia by mail, send a postcard with your mailing address to: Cinavia Consumer Information Center, P.O. Box 86851, San Diego, CA, 92138, USA.

Copyrights and Trademarks

- Java is a trademark of Oracle and/or its affiliates.
- Manufactured under license from Dolby Laboratories. Dolby and the double-D symbol are trademarks of Dolby Laboratories.
- For DTS patents, see <http://patents.dts.com>. Manufactured under license from DTS Licensing Limited. DTS, the Symbol, & DTS and the Symbol together are registered trademarks, and DTS 2.0+Digital Out is a trademark of DTS, Inc. © DTS, Inc. All Rights Reserved.



- The terms HDMI[®] and HDMI High-Definition Multimedia Interface, and the HDMI Logo are trademarks or registered trademarks of HDMI Licensing Administrator, Inc. in the United States and other countries.
- Blu-ray Disc[™], Blu-ray[™], BD-LIVE[™], BONUSVIEW[™], and the logos are trademarks of the Blu-ray Disc Association.
- “DVD Logo” is a trademark of DVD Format/Logo Licensing Corporation.
- “DVD+RW,” “DVD-RW,” “DVD+R,” “DVD-R,” “DVD VIDEO,” and “CD” logos are trademarks.
- “BRAVIA” is a trademark of Sony Corporation.
- MPEG Layer-3 audio coding technology and patents licensed from Fraunhofer IIS and Thomson.

- This product incorporates proprietary technology under license from Verance Corporation and is protected by U.S. Patent 7,369,677 and other U.S. and worldwide patents issued and pending as well as copyright and trade secret protection for certain aspects of such technology. Cinavia is a trademark of Verance Corporation. Copyright 2004-2010 Verance Corporation. All rights reserved by Verance. Reverse engineering or disassembly is prohibited.
- Windows Media is either a registered trademark or trademark of Microsoft Corporation in the United States and/or other countries.

This product is protected by certain intellectual property rights of Microsoft Corporation. Use or distribution of such technology outside of this product is prohibited without a license from Microsoft or an authorized Microsoft subsidiary. Content owners use Microsoft PlayReady[™] content access technology to protect their intellectual property, including copyrighted content. This device uses PlayReady technology to access PlayReady-protected content and/or WMDRM-protected content. If the device fails to properly enforce restrictions on content usage, content owners may require Microsoft to revoke the device’s ability to consume PlayReady-protected content. Revocation should not affect unprotected content or content protected by other content access technologies. Content owners may require you to upgrade PlayReady to access their content. If you decline an upgrade, you will not be able to access content that requires the upgrade.

- Gracenote, the Gracenote logo and logotype, “Powered by Gracenote”, Gracenote MusicID, Gracenote VideoID, and Gracenote Video Explore are either registered trademarks or trademarks of Gracenote, Inc. in the United States and/or other countries.



- Wi-Fi[®], Wi-Fi Protected Access[®], Wi-Fi Alliance[®] and Miracast[®] are registered trademarks of Wi-Fi Alliance.*
- Wi-Fi CERTIFIED[™], WPA[™], WPA2[™], Wi-Fi Protected Setup[™] and Wi-Fi CERTIFIED Miracast[™] are trademarks of Wi-Fi Alliance.*
- The Wi-Fi CERTIFIED Logo is a certification mark of Wi-Fi Alliance.*
- The Wi-Fi Protected Setup Identifier Mark is a certification mark of Wi-Fi Alliance.*
- DLNA[™], the DLNA Logo and DLNA CERTIFIED[™] are trademarks, service marks, or certification marks of the Digital Living Network Alliance.*



- Opera[®] Devices SDK from Opera Software ASA. Copyright 1995-2015 Opera Software ASA. All rights reserved.



- All other trademarks are trademarks of their respective owners.
- Other system and product names are generally trademarks or registered trademarks of the manufacturers. [™] and [®] marks are not indicated in this document.

* BDP-S3700 only

Gracenote[®] End User License Agreement

This application or device contains software from Gracenote, Inc. of Emeryville, California (“Gracenote”). The software from Gracenote (the “Gracenote Software”) enables this application or device to perform disc and/or file identification and obtain music- and/or video-related information, including name, artist, track, and title information (“Gracenote Data”) from online servers or embedded databases (collectively, “Gracenote Servers”), and to perform other functions. You may use Gracenote Data only by means of the intended End-User functions of this application or device; the reception and display of the Gracenote Data on this application or device are not provided by Gracenote and falls solely within the responsibility and liability of the manufacturer hereof.

This application or device may contain content belonging to Gracenote’s providers. If so, all of the restrictions set forth herein with respect to Gracenote Data shall also apply to such content, and said content providers shall be entitled to all of the benefits and protections that are available to Gracenote hereunder. You agree that you will use Gracenote Data, the Gracenote Software, and Gracenote Servers for your own personal, non-commercial use only. You agree not to assign, copy, transfer or transmit the Gracenote Software or any Gracenote Data to any third party. **YOU AGREE NOT TO USE OR EXPLOIT GRACENOTE DATA, THE GRACENOTE SOFTWARE, OR GRACENOTE SERVERS EXCEPT AS EXPRESSLY PERMITTED HEREIN.**

You agree that your non-exclusive license to use the Gracenote Data, the Gracenote Software, and Gracenote Servers will terminate if you violate these restrictions. If your license terminates, you agree to cease any and all use of the Gracenote Data, the Gracenote Software, and Gracenote Servers.

Gracenote reserves all rights in Gracenote Data, the Gracenote Software, and the Gracenote Servers, including all ownership rights. Under no circumstances will Gracenote become liable for any payment to you for any information that you provide. You agree that Gracenote may enforce its rights under this Agreement against you directly in its own name. Gracenote may amend or remove Gracenote Data with or without advance notice and may block or modify access to Gracenote Data; you do not have any claim against Gracenote arising out of such change, removal, blocking or modification.

PLEASE NOTE that in order to use the Gracenote Data, specific technical pre-requisites, such as this application or device, software programs, methods of transfer, telecommunication services and other third party services, usually need to be used, for which additional cost, in particular connection charges, can be incurred, which you will have to pay for separately. Gracenote does not provide such applications or devices, software programs, methods of transfer, telecommunication services or other services, and does not accept any liability for services of third parties. Gracenote is not responsible for the proper setup, connection or (if applicable) equipment of this application or device so that Gracenote Data may be received; this lies within your sole responsibility.

The Gracenote service uses a unique identifier to track queries for statistical purposes. The purpose of a randomly assigned numeric identifier is to allow the Gracenote service to count queries without knowing anything about who you are. For more information, see the web page for the Gracenote Privacy Policy for the Gracenote service.

The Gracenote Software and each item of Gracenote Data are licensed to you "AS IS." Gracenote makes no representations or warranties, express or implied, regarding the accuracy of any Gracenote Data from the Gracenote Servers; the download or any other receipt of content, in particular the download of Gracenote Data, is also at your own risk and you are solely responsible for any damage to this application or device or for any other damages, including loss of data, arising out of such actions. Gracenote reserves the right to delete data from the Gracenote Servers or to change data categories for any cause that Gracenote deems sufficient. No warranty is made that the Gracenote Software or Gracenote Servers are error-free or that functioning of Gracenote Software or Gracenote Servers will be uninterrupted. Gracenote is not obligated to provide you with new, enhanced or additional data types or categories that Gracenote may provide in the future, and is free to discontinue its services at any time.

GRACENOTE DISCLAIMS ALL WARRANTIES EXPRESS OR IMPLIED, INCLUDING, BUT NOT LIMITED TO, IMPLIED WARRANTIES OF MERCHANTABILITY, FITNESS FOR A PARTICULAR PURPOSE, TITLE, AND NON-INFRINGEMENT. GRACENOTE DOES NOT WARRANT THE RESULTS THAT WILL BE OBTAINED BY YOUR USE OF THE GRACENOTE SOFTWARE, GRACENOTE DATA OR ANY GRACENOTE SERVER. IN NO CASE WILL GRACENOTE BE LIABLE FOR ANY CONSEQUENTIAL OR INCIDENTAL DAMAGES OR FOR ANY LOST PROFITS OR LOST REVENUES.

© 2000 – present. Gracenote, Inc. All Rights Reserved.

➔ *continued to page 10*

Contents

- 2 WARNING
- 4 Precautions

Getting Started

- 11 Guide to Parts and Controls
- 15 Step 1: Connecting the Player
- 16 Step 2: Preparing for Network Connection
- 16 Step 3: Easy Setup

Playback

- 19 Playing a Disc
- 20 Playing from a USB Device
- 20 Playing via a Network
- 22 Available Options

Settings and Adjustments

- 24 Using the Settings Displays
- 24 [Software Update]
- 24 [Screen Settings]
- 26 [Audio Settings]
- 27 [BD/DVD Viewing Settings]
- 27 [Parental Control Settings]
- 28 [System Settings]
- 29 [Network Settings]
- 30 [Easy Network Settings]
- 30 [Resetting]

Additional Information

- 31 Troubleshooting
- 35 Specifications

Software License Information

For EULA (End User License Agreement), please refer to [License agreement] in the option menu on each network service icon.

For details of the other software licenses, please select [Setup] and refer to [Software License Information] in [System Settings].

This product contains software that is subject to the GNU General Public License (“GPL”) or GNU Lesser General Public License (“LGPL”). These licenses establish that customers have the right to acquire, modify, and redistribute the source code of said software in accordance with the terms of the GPL or the LGPL.

The source code for the software used in this product is subject to the GPL and LGPL, and is available on the Web. To download, please visit the following website:

<http://oss.sony.net/Products/Linux>

Please note that Sony cannot respond to any inquiries regarding the content of this source code.

Disclaimer regarding services offered by third parties

Services offered by third parties may be changed, suspended, or terminated without prior notice. Sony does not bear any responsibility in these sorts of situations.

Guide to Parts and Controls

Front panel

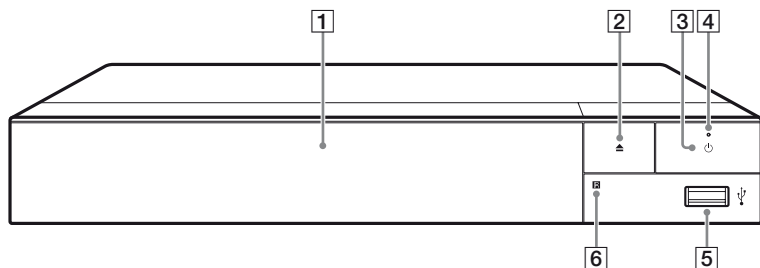

- 1 Door tray**
- 2 ▲ (open/close)**
- 3 ⏻ (on/standby)**
Turns on the player, or sets to standby mode.
- 4 Power indicator**
Lights up when the player is turned on.
- 5 USB (USB) jack**
Connect a USB device to this jack.
- 6 Remote sensor**

To lock the disc tray (Child Lock)

You can lock the disc tray to avoid accidental opening of the tray.

While the player is turned on, press ■ (stop), HOME, and then TOP MENU button on the remote to lock or unlock the tray.

Rear panel

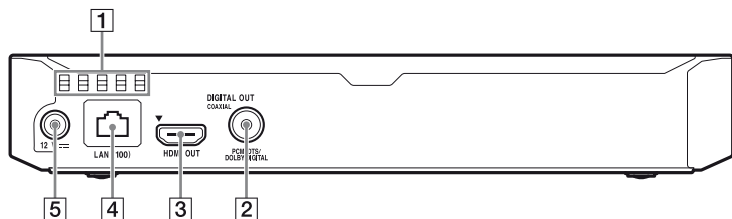



- 1** Ventilation holes
- 2** DIGITAL OUT (COAXIAL) jack
- 3** HDMI OUT jack
- 4** LAN (100) terminal
- 5** DC IN 12 V (AC adaptor input) jack

Remote

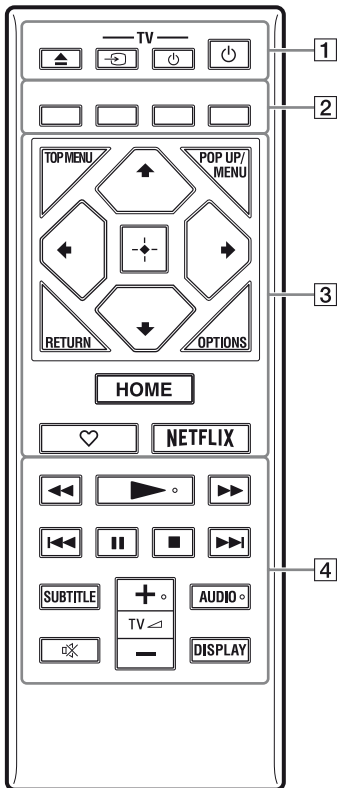
The available functions of the remote are different depending on the disc or the situation.



 , TV  +, and AUDIO buttons have a tactile dot. Use the tactile dot as a reference when operating the player.

1 ▲ (open/close)

Opens or closes the disc tray.

-TV- (TV input select)

Switches between TV and other input sources.

-TV- (TV on/standby)

Turns on the TV, or sets to standby mode.

(on/standby)

Turns on the player, or sets to standby mode.

2 Colour buttons (red/green/yellow/blue)

Shortcut keys for interactive functions.

3 TOP MENU

Opens or closes the BD's or DVD's Top Menu.

POP UP/MENU

Opens or closes the BD-ROM's Pop-up Menu, or the DVD's menu.

OPTIONS (page 22)

Displays the available options on the screen.



RETURN

Returns to the previous display.



Moves the highlight to select a displayed item.



-  as a shortcut key to launch track search window and input track number during music CD playback.
-  as a shortcut key to rotate photo clockwise/counterclockwise by 90 degrees.
-  as a shortcut key to perform search functions during DLNA video playback (BDP-S3700 only).

Centre button (ENTER)

Enters the selected item.

HOME

Enters the player's home screen.

♥ (favourite) (page 18)

Accesses the application registered as favourite.

NETFLIX

Accesses the "NETFLIX" online service. For further NETFLIX online service details, visit the following website and check the FAQ: www.sony.eu/support

4 ◀◀/▶▶ (fast reverse/fast forward)

- Fast reverse/fast forward the disc when you press the button during playback. The search speed changes each time you press the button during video playback.
- Plays in slow motion, when pressed for more than one second in pause mode.
- Plays one frame at a time, when you press for a short time in pause mode.

▶ (play)

Starts or re-starts playback.

◀◀/▶▶ (previous/next)

Skips to the previous/next chapter, track, or file.

|| (pause)

Pauses or re-starts playback.

■ (stop)

Stops playback and remembers the stop point (resume point).

The resume point for a title/track is the last point you played or the last photo for a photo folder.

SUBTITLE (page 27)

Selects the subtitle language when multi-lingual subtitles are recorded on BD-ROMs/DVD VIDEOS.

TV ⏏ (volume) +/-

Adjusts the TV volume.

AUDIO (page 27)

Selects the language track when multi-lingual tracks are recorded on BD-ROMs/DVD VIDEOS.

Selects the sound track on CDs.

🔇 (muting)

Turns off the sound temporarily.

DISPLAY (page 20)

Displays the playback information on the screen.

Code numbers of controllable TVs

Hold down -TV- ⏻ and the TV manufacturer's code using the remote buttons for 2 seconds.

If more than one remote button is listed, try entering them one at a time until you find the one that works with your TV.

Manufacturer	Remote Button
Sony (Default)	Colour button (red)
Philips	Colour button (green) / Colour button (yellow) / RETURN
Panasonic	Colour button (blue) / Centre button (ENTER)
Hitachi	TOP MENU
Sharp	↑
Toshiba	POP UP/MENU
Loewe	←
Samsung	→
LG/Goldstar	↓

Step 1: Connecting the Player

Do not connect the mains lead until you have made all the connections.

Connecting to your TV

Connect the player to your TV with a High Speed HDMI Cable.

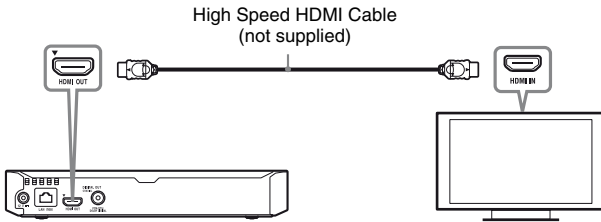

Connecting to your AV amplifier (receiver)

Select one of the following connection methods according to the input jacks on your AV amplifier (receiver).

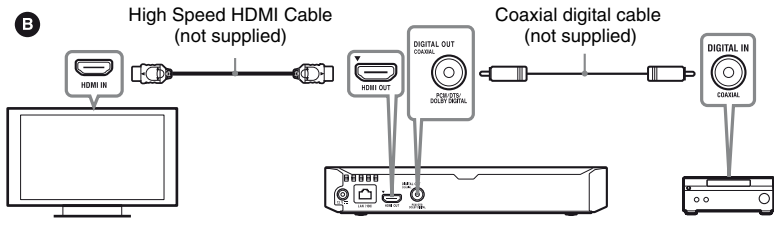
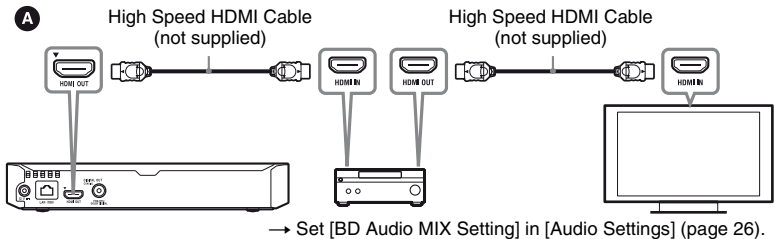

Step 2: Preparing for Network Connection

If you are not going to connect the player to a network, proceed to “Step 3: Easy Setup” (page 16).

Wired Setup

Use a LAN cable to connect to the LAN (100) terminal on the player.

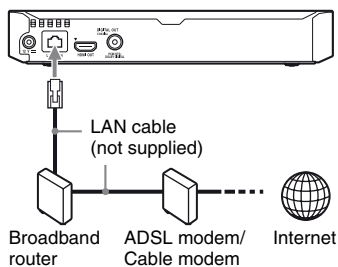

The use of a shielded and straight interface cable (LAN cable) is recommended.

Wireless Setup (BDP-S3700 only)

Use the wireless LAN that is built into the player.

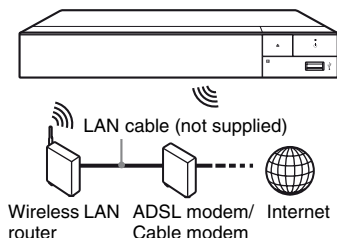

Step 3: Easy Setup

When turned on for the first time

Wait for a short while before the player turns on and starts [Easy Initial Settings].

- 1** Insert two R03 (size AAA) batteries by matching the \oplus and \ominus ends on the batteries to the markings inside the battery compartment of the remote.

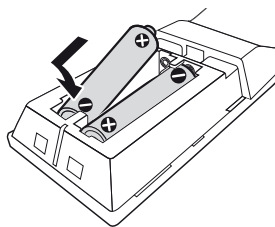

- 2 Connect the supplied AC adaptor and AC power cord (mains lead) in the numeric order shown below. When removing them, do so in reverse order.**

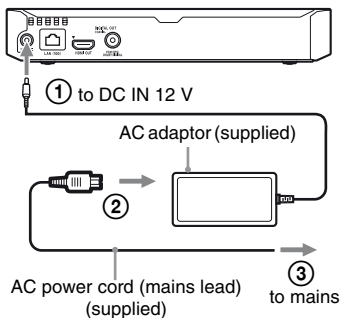



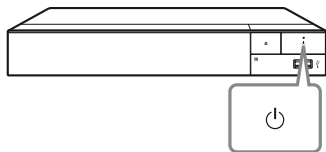

- 3 Press  to turn on the player.**



- 4 Turn on the TV and set the input selector on your TV by pressing  button on the remote. This will show the signal from the player on your TV screen.**

- 5 Perform [Easy Initial Settings].**

Follow the on-screen instructions to make the basic settings using /// and ENTER on the remote.

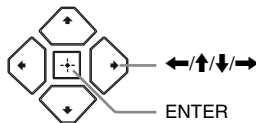

- When [Easy Initial Settings] is complete, select [Easy Network Settings] to use the network functions of the player.
- To enable wireless connection, set [Internet Settings] in [Network Settings] to [Wireless Setup] (BDP-S3700 only).
- To disable wireless connection, set [Internet Settings] in [Network Settings] to [Wired Setup] (BDP-S3700 only).

Home screen display

The home screen appears when you press HOME. Select an application using ←/↑/↓/→, and press ENTER.

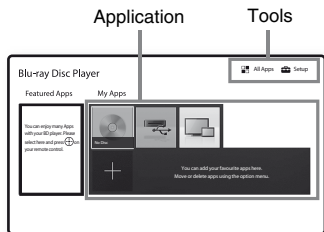

[My Apps]: Manages favourite application. You may add shortcuts for application from [All Apps].

[Featured Apps]: Displays recommended application.

[All Apps]: Shows all available applications. You can add applications to [My Apps] by pressing OPTIONS, and select [Add to My Apps].

[Setup]: Adjusts the player's settings.



Screen mirroring function is only available for BDP-S3700.

Available options

Various settings and playback operations are available by pressing OPTIONS. The available items differ depending on the situation.

[Move Application]: Arranges applications in [My Apps].

[Remove Application]: Deletes applications in [My Apps].

[Register as Favourite]: Registers 1 application into ♥ (favourite) remote button.

[Data Contents]: Displays the contents of the mixed disc.

Playing a Disc

For “Playable discs”, see page 36.

- 1 **Switch the input selector on your TV so that the signal from the player appears on your TV screen.**
- 2 **Press \blacktriangle , and place a disc on the disc tray.**

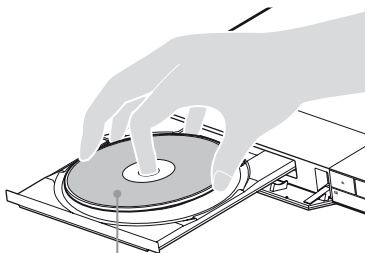

Playing side facing down

- 3 **Press \blacktriangle to close the disc tray.**
Playback starts.
If playback does not start automatically, select [Video], [Music], or [Photo] category in \bullet (Disc), and press ENTER.



\bullet (Mixed disc) contains data contents. Press OPTIONS on the remote and select [Data Contents] to display any available contents.

Enjoying BONUSVIEW/ BD-LIVE

Some BD-ROMs with the “BD-LIVE” logo have bonus contents and other data that can be downloaded for your enjoyment.



- 1 **Connect a USB memory to the USB jack on the player (page 11).**
Use a 1 GB or larger USB memory as your local storage.
- 2 **Prepare for BD-LIVE (BD-LIVE only).**
 - Connect the player to a network (page 16).
 - Set [BD Internet Connection] in [BD/DVD Viewing Settings] to [Allow] (page 27).
- 3 **Insert a BD-ROM with BONUSVIEW/BD-LIVE.**
The operation method differs depending on the disc. Refer to the instruction manual supplied with the disc.



To delete data in the USB memory, select [Delete BD Data] in [BD/DVD Viewing Settings], and press ENTER. All data stored in the buda folder will be erased.

Displaying the play information

You can view the playback information, etc., by pressing DISPLAY.

The displayed information differs depending on the disc type and player status.

Example: when playing a BD-ROM

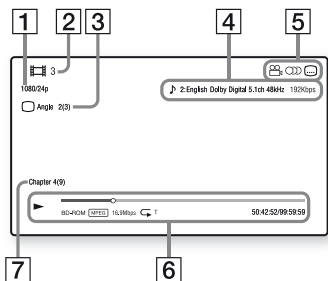

- 1 Output resolution/Video frequency
- 2 Title number or name
- 3 The currently selected angle
- 4 The currently selected audio setting
- 5 Available functions (angle, audio, subtitle)
- 6 Playback information
Displays the Play mode, Playing status bar, Disc type, Video codec, Bitrate, Repeat type, Elapsed time, and Total playing time.
- 7 Chapter number

Playing from a USB Device

For “Playable types of files”, see page 37.

- 1 **Connect the USB device to the USB jack on the player (page 11).**
Refer to the instruction manual supplied with the USB device before connecting.
- 2 Select [USB device] using ←/↑/↓/→, and press ENTER.
- 3 Select [Video], [Music], or [Photo] category using ↑/↓, and press ENTER.

Playing via a Network

Playing files on a Home Network (DLNA) (BDP-S3700 only)

A DLNA-compatible product can play video/music/photo files stored on another DLNA-compatible product via a network.

- 1 **Prepare to use DLNA.**
 - Connect the player to a network (page 16).
 - Prepare the other necessary DLNA-compatible products.
Refer to the instruction manual supplied with the product.

To play a file from a DLNA server via this unit (DLNA player)

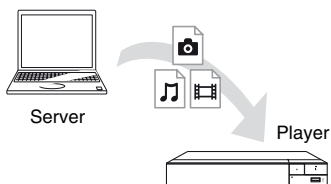

Select [Video], [Music], or [Photo] category from  [Media Server] in [All Apps], then choose the file you want to play.

To play a file from a DLNA server via another product (Renderer)

When you play files from a DLNA Server on this unit, you can use a DLNA Controller-compatible product (a phone, etc.), to control playback.

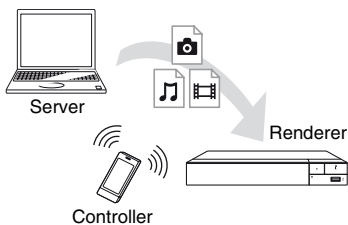

Control this unit using a DLNA controller. Refer to the instruction manual supplied with the DLNA controller.

Using “Video & TV SideView” (BDP-S3700 only)

“Video & TV SideView” is a free mobile application for remote devices (such as smartphone, etc.). By using “Video & TV SideView” with this player, you can easily enjoy the player by using the operation on your remote device. You can launch a service or application directly from the remote device and view the disc information during disc playback. “Video & TV SideView” also can be used as a remote control and software keyboard.

Before you use the “Video & TV SideView” device with this player for the first time, be sure to register the “Video & TV SideView” device. Follow the on-screen instructions on the “Video & TV SideView” device for registration.







The registration can only be performed on the home screen.

Using Screen mirroring (BDP-S3700 only)

“Screen mirroring” is a function to display the screen of a mobile device on the TV by Miracast technology. The player can be connected directly with a Screen mirroring compatible device (e.g. smartphone, tablet). You can enjoy the display screen of the device on your large TV screen. No wireless router (or access point) is required to use this feature.



- When using Screen mirroring, the quality of picture and sound may sometimes be deteriorated due to interference from other network. You may improve by adjusting [Screen mirroring RF Setting] (page 29).
- Some network functions may not be available during Screen mirroring.
- Make sure that the device is compatible with Miracast. Connectivity with all Miracast compatible devices is not guaranteed.

1 Select  [Screen mirroring] from home screen using ///, and press ENTER.

2 Follow the on-screen instructions.

Available Options

Various settings and playback operations are available by pressing OPTIONS. The available items differ depending on the situation.

Common options

- **[Repeat Setting]:** Sets the repeat mode.
- **[Play]/[Stop]:** Starts or stops the playback.
- **[Play from start]:** Plays the item from the beginning.

Video only

- **[A/V SYNC]:** Adjusts the gap between picture and sound, by delaying the sound output in relation to the picture output (0 to 120 milliseconds).

■ [Video Settings]:

- [Picture Quality Mode]: Selects the picture settings for different lighting environments.
- [BNR]: Reduces the mosaic-like block noise in the picture.
- [MNR]: Reduces minor noise around the picture outlines (mosquito noise).

■ [Pause]:

Pauses the playback.

■ [Top Menu]:

Displays the BD's or DVD's Top Menu.

■ [Menu]/[Popup Menu]:

Displays the BD-ROM's Pop-up Menu or DVD's menu.

■ [Title Search]:

Searches for a title on BD-ROMs/DVD VIDEOS and starts playback from the beginning.

■ [Chapter Search]:

Searches for a chapter and starts playback from the beginning.

■ [Audio]:

Switches the language track when multilingual tracks are recorded on BD-ROMs/DVD VIDEOS. Selects the sound track on CDs.

■ [Subtitle]:

Switches the subtitle language when multilingual subtitles are recorded on BD-ROMs/DVD VIDEOS.

■ [Angle]:

Switches to other viewing angles when multi-angles are recorded on BD-ROMs/DVD VIDEOS.

■ [Number Entry]:

Selects the number by using /// key on the remote.

- **[Video Search]:** Displays information on the BD-ROM/DVD-ROM based on Gracenote technology. Searches for related information using keywords from Gracenote when selecting [Cast] or [Related]. Displays a list of titles when selecting [Playback History] or [Search History].

Music only

- **[Track Search]:** Searches the track number during music CD playback.
- **[Add Slideshow BGM]:** Registers music files in the USB memory as slideshow background music (BGM).
- **[Music Search]:** Displays information on the audio CD (CD-DA) based on Gracenote technology. Searches for related information using keywords from Gracenote when selecting [Track], [Artist] or [Related]. Displays a list of titles when selecting [Playback History] or [Search History].
- **[Shuffle Setting]:** Set to [On] to playback music files in randomised order.

Photo only







- **[Slideshow Speed]:** Changes the slideshow speed.
- **[Slideshow Effect]:** Sets the effect for slideshows.
- **[Slideshow BGM]:**
 - [Off]: Turns off the function.
 - [My Music from USB]: Sets the music files registered in [Add Slideshow BGM].
 - [Play from Music CD]: Sets the tracks in CD-DAs.
- **[Change Display]:** Switches between [Grid View] and [List View].
- **[View Image]:** Displays the selected photo.
- **[Slideshow]:** Plays a slideshow.
- **[Rotate Left]:** Rotates the photo counterclockwise by 90 degrees.
- **[Rotate Right]:** Rotates the photo clockwise by 90 degrees.

Settings and Adjustments

Using the Settings Displays

Select  [Setup] on the home screen when you need to change the settings of the player.

The default settings are underlined.

- 1** Select  [Setup] on the home screen using ///.
- 2** Select the setup category icon using /, and press ENTER.

[Software Update]

■ [Update via Internet]

Updates the player's software using available network. Make sure that the network is connected to the Internet. For details, see "Step 2: Preparing for Network Connection" (page 16).

■ [Update via USB Memory]

Updates the player's software using USB memory. Make sure that the Software Update Folder is correctly named as "UPDATE" and all the update files must be stored in this folder. The player can recognise up to 500 files/folders in a single layer including the update files/folders.



- We recommend performing the software update every 2 months or so.

- If your network condition is poor, visit www.sony.eu/support to download the latest software version and update via USB memory.

You can also get information about update functions from the website.

[Screen Settings]

■ [TV Type]

[16:9]: Select this when connecting to a wide-screen TV or a TV with a wide mode function.

[4:3]: Select this when connecting to a 4:3 screen TV without a wide mode function.

■ [Screen Format]

[Full]: Select this when connecting to a TV with a wide mode function. Displays a 4:3 screen picture in 16:9 aspect ratio even on a wide-screen TV.

[Normal]: Changes the picture size to fit the screen size with the original picture aspect ratio.

■ [DVD Aspect Ratio]

[Letter Box]: Displays a wide picture with black bands on the top and bottom.



[Pan & Scan]: Displays a full-height picture on the entire screen, with trimmed sides.

**■ [Cinema Conversion Mode]**

[Auto]: Normally select this. The player automatically detects whether the material is video-based or film-based, and switches to the appropriate conversion method.

[Video]: The conversion method suited for video-based material will always be selected regardless of the material.

■ [Output Video Resolution]

Normally select [Auto]. Select [Original Resolution] to output the resolution recorded on the disc. When the resolution is lower than the SD resolution, it is scaled up to the SD resolution.

■ [24p Output]

Outputs 24p video signals only when you connect a 1080/24p-compatible TV via an HDMI connection and the [Output Video Resolution] is set to [Auto] or [1080p].

[BD-ROM 24p Output]

[Auto]: Outputs 1920 × 1080p/24 Hz video signals only when connecting a 1080/24p-compatible TV using the HDMI OUT jack.

[On]: Turns on the function.

[Off]: Select this when your TV is not compatible with 1080/24p video signals.

[DVD-ROM 24p Output]

[Auto]: Outputs 1920 × 1080p/24 Hz video signals only when connecting a 1080/24p-compatible TV using the HDMI OUT jack.

[Off]: Select this when your TV is not compatible with 1080/24p video signals.

[Data content 24p Output]

This function is available for playback contents stored in USB memory or data disc.

[Auto]: Outputs 1920 × 1080p/24 Hz video signals only when connecting a 1080/24p-compatible TV using the HDMI OUT jack.

[Off]: Select this when your TV is not compatible with 1080/24p video signals.

[Network content 24p Output]

This function is available for playback contents from other network, such as Home Network, Screen mirroring, etc.

[Auto]: Outputs 1920 × 1080p/24 Hz video signals only when connecting a 1080/24p-compatible TV using the HDMI OUT jack.

[Off]: Select this when your TV is not compatible with 1080/24p video signals.

■ [YCbCr/RGB (HDMI)]

[Auto]: Automatically detects the connected TV type, and switches to the matching colour setting.

[YCbCr (4:2:2)]: Outputs YCbCr 4:2:2 video signals.

[YCbCr (4:4:4)]: Outputs YCbCr 4:4:4 video signals.

[RGB]: Outputs RGB video signals.

■ [HDMI Deep Colour Output]

[Auto]: Normally select this.

[16bit]/[12bit]/[10bit]: Outputs 16bit/12bit/10bit video signals when the connected TV is compatible with Deep Colour.

[Off]: Select this when the picture is unstable or colours appear unnatural.

■ [Pause Mode]

[Auto]: Normally select this. Dynamic moving pictures appear without blurring.

[Frame]: Displays static pictures at high resolution.

[Audio Settings]

■ [Digital Audio Output]

[Auto]: Normally select this. Outputs audio signals according to the status of the connected devices.

[PCM]: Outputs PCM signals from the DIGITAL OUT (COAXIAL)/HDMI OUT jack.

■ [DSD Output Mode]

[Auto]: Outputs DSD signals from the HDMI OUT jack when playing DSD format file. Outputs LPCM signals instead if the HDMI connected device not support DSD.

[Off]: Outputs PCM signals from the HDMI OUT jack when playing DSD format file.

■ [BD Audio MIX Setting]

[On]: Outputs the audio obtained by mixing the interactive and secondary audio to the primary audio.

[Off]: Outputs the primary audio only. Select this to output HD audio signals to an AV amplifier (receiver).

■ [Dolby D Compatible Output]

[On]: Converts DTS audio source to Dolby Digital audio by using EDID (Extended Display Identification Data).

[Off]: Turns off the function.

■ [Audio DRC]

[Auto]: Performs playback at the dynamic range specified by the disc (BD-ROM only). Other discs are played back at the [On] level.

[On]: Performs playback at a standard compression level.

[Off]: No compression works. A more dynamic sound is produced.

■ [Downmix]

[Surround]: Outputs audio signals with surround effects. Select this when connecting an audio device that supports Dolby Surround (Pro Logic) or DTS Neo:6.

[Stereo]: Outputs audio signals without surround effects. Select this when connecting an audio device that does not support Dolby Surround (Pro Logic) or DTS Neo:6.

● [BD/DVD Viewing Settings]

■ [BD/DVD Menu Language]

Selects the default menu language for BD-ROMs or DVD VIDEOS. Select [Select Language Code], and enter the code for your language, referring to “Language code list” (page 40).

■ [Audio Language]

Selects the default audio language for BD-ROMs or DVD VIDEOS. When you select [Original], the language given priority in the disc is selected. Select [Select Language Code], and enter the code for your language, referring to “Language code list” (page 40).

■ [Subtitle Language]

Selects the default subtitle language for BD-ROMs or DVD VIDEOS. Select [Select Language Code], and enter the code for your language, referring to “Language code list” (page 40).

■ [BD Hybrid Disc Playback Layer]

[BD]: Plays BD layer.

[DVD/CD]: Plays DVD or CD layer.

■ [BD Internet Connection]

[Allow]: Normally select this.

[Do not allow]: Prohibits Internet connection.

■ [Delete BD Data]

Deletes data in the USB memory.

All data stored in the buda folder will be erased.

🔒 [Parental Control Settings]

■ [Password]

Sets or changes the password for the Parental Control function. A password allows you to set a restriction on BD-ROM or DVD VIDEO, and Internet video playback. If necessary, you can differentiate the restriction levels for BD-ROMs, DVD VIDEOS, and Internet videos.

■ [Parental Control Area Code]

Playback of some BD-ROMs, DVD VIDEOS, or Internet videos can be limited according to the geographic area. Scenes may be blocked or replaced with different scenes. Follow the on-screen instructions and enter your four-digit password.

■ **[BD Parental Control] /
[DVD Parental Control] /
[Internet Video Parental Control]**

By setting Parental Control, scenes can be blocked or replaced with different scenes. Follow the on-screen instructions and enter your four-digit password.

■ **[Internet Video Unrated]**

[Allow]: Allows the playback of unrated Internet videos.

[Block]: Blocks the playback of unrated Internet videos.

[System Settings]

■ **[OSD Language]**

Selects on-screen display language for your player.

■ **[HDMI Settings]**

By connecting Sony components that are compatible with HDMI functions with a High Speed HDMI Cable, operation is simplified.

[Control for HDMI]

[On]: The following BRAVIA Sync features are available:

- One-Touch Play
- System Power-Off
- Language Follow

[Off]: Turns off the function.



For details, refer to the instruction manual supplied with the TV or components.

[Linked to TV-off]

[Valid]: Automatically turns off the player when the connected TV enters standby mode (BRAVIA Sync).

[Invalid]: Turns off the function.

■ **[Network Start Mode]**

[On]: Turns on Network standby function (page 35).

[Off]: Turns off the function.

■ **[Auto Standby]**

[On]: Automatically returns to standby mode if no button is pressed for more than 20 minutes.

[Off]: Turns off the function.

■ **[Auto Display]**

[On]: Automatically displays information on the screen when changing the viewing titles, picture modes, audio signals, etc.

[Off]: Displays information only when you press DISPLAY.

■ **[Software Update Notification]**

[On]: Sets the player to inform you of newer software version information (page 24).

[Off]: Turns off the function.

■ **[Gracenote Settings]**

[Auto]: Automatically downloads disc information when disc playback stops. Connect to the network for downloading.

[Manual]: Downloads the disc information when [Video Search] or [Music Search] is selected.

■ **[Device Name] (BDP-S3700 only)**

Displays the player's name. The player's name can be changed.

■ [System Information]

Displays the player's software version information and the MAC address.

■ [Software License Information]

Displays information about the Software License.

 **[Network Settings]**

■ [Internet Settings]

Connect the player to the network beforehand. For details, see "Step 2: Preparing for Network Connection" (page 16).

[Wired Setup] (BDP-S3700 only):

Select this when you connect to a broadband router using a LAN cable.

[Wireless Setup] (BDP-S3700 only):

Select this when you use the wireless LAN that is built into the player for wireless network connection.



For further details, visit the following website and check the FAQ contents:

www.sony.eu/support

■ [Network Connection Status]

Displays the current network status.

■ [Network Connection Diagnostics]

Checks for the proper network connection by running the network diagnostics.

■ [Screen mirroring RF Setting] (BDP-S3700 only)

[Auto]: Sets the RF (Radio Frequency) channel band automatically for Screen mirroring connection.

[CH 1]/[CH 6]/[CH 11]: Sets CH 1/CH 6/CH 11 as priority.

■ [Connection Server Settings] (BDP-S3700 only)

Sets whether or not to display the connected server.

■ [Auto Home Network Access Permission] (BDP-S3700 only)

[On]: Allows automatic access from newly detected DLNA controller-compatible product.

[Off]: Turns off the function.

■ [Home Network Access Control] (BDP-S3700 only)

Displays a list of DLNA controller-compatible products and sets whether or not to accept commands from the controllers in the list.

■ [Registered Remote Devices] (BDP-S3700 only)

Displays a list of your registered remote devices.

■ [Remote Start]

[On]: Allows you to turn on the player by a device linked via a network.

[Off]: Turns off the function.



Set [Remote Start] to [On] and turn off the player to activate Network standby (page 35).



[Easy Network Settings]

Select [Easy Network Settings] to specify the network settings. Follow the on-screen instructions.



[Resetting]

■ [Reset to Factory Default Settings]

Resets the player settings to the factory default by selecting the group of settings. All the settings within the group will be reset.

■ [Initialise Personal Information]

Erases your personal information stored in the player.



If you dispose, transfer or resell this unit, please delete all Personal Information for security purposes. Please take the appropriate measures such as logging out after using a network service.

Additional Information

Troubleshooting

If you experience any of the following difficulties while using the player, use this troubleshooting guide to help remedy the problem before requesting repairs. Should any problem persist, consult your nearest Sony dealer.

Picture

There is no picture or the picture is not output correctly.

- ➔ Check that all the connecting cables are securely connected (page 15).
- ➔ Switch the input selector on your TV to display the signal from the player.
- ➔ Reset the [Output Video Resolution] to the lowest resolution by pressing ■ (stop), HOME, and then POP UP/MENU button on the remote.
- ➔ Try the following: ①Turn the player off and on again. ②Turn the connected equipment off and on again. ③Disconnect and then reconnect the HDMI cable.
- ➔ The HDMI OUT jack is connected to a DVI device that does not support copyright protection technology.
- ➔ Check the [Output Video Resolution] settings in [Screen Settings] (page 25).
- ➔ For BD-ROMs/DVD-ROMs/Data content/Network content, check the [24p Output] settings in [Screen Settings] (page 25).

The display language on the screen switches automatically when connected to the HDMI OUT jack.

- ➔ When [Control for HDMI] in [HDMI Settings] is set to [On] (page 28), the display language on the screen automatically switches according to the language setting of the connected TV (if you change the setting on your TV, etc.).

Sound

There is no sound or the sound is not output correctly.

- ➔ Check that all the connecting cables are securely connected (page 15).
- ➔ Switch the input selector on your AV amplifier (receiver) so that the audio signals of the player are output from your AV amplifier (receiver).
- ➔ If the audio signal does not come through the DIGITAL OUT (COAXIAL)/HDMI OUT jack, check the audio settings (page 26).
- ➔ For HDMI connections, try the following: ①Turn the player off and on again. ②Turn the connected equipment off and on again. ③Disconnect and then reconnect the HDMI cable.
- ➔ For HDMI connections, if the player is connected to a TV through an AV amplifier (receiver), try connecting the HDMI cable directly to the TV. Refer also to the instruction manual supplied with the AV amplifier (receiver).
- ➔ The HDMI OUT jack is connected to a DVI device (DVI jacks do not accept audio signals).

- ➔ The device connected to the HDMI OUT jack does not support the audio format of the player. Check the audio settings (page 26).

The HD Audio (Dolby Digital Plus, Dolby TrueHD, DTS-HD High Resolution Audio, and DTS-HD Master Audio) is not output by bitstream.

- ➔ Set [BD Audio MIX Setting] in [Audio Settings] to [Off] (page 26).
- ➔ Check that the connected AV amplifier (receiver) is compatible with each HD Audio format.

The interactive audio is not output.

- ➔ Set [BD Audio MIX Setting] in [Audio Settings] to [On] (page 26).

Message Code 3 [Audio outputs temporarily muted. Do not adjust the playback volume. The content being played is protected by Cinavia and is not authorized for playback on this device. For more information, see <http://www.cinavia.com>. Message Code 3.] appears on the screen when playing a disc.

- ➔ The audio track of the video that you are playing contains a Cinavia code indicating that it is an unauthorised copy of professionally-produced content (page 5).

Disc

The disc does not play.

- ➔ The disc is dirty or skewed.
- ➔ The disc is upside down. Insert the disc with the playback side facing down.
- ➔ The disc has a format that cannot be played back by this player (page 36).
- ➔ The player cannot play a recorded disc that is not correctly finalised.
- ➔ The region code on the BD or DVD does not match the player.

USB device

The player does not detect a USB device connected to the player.

- ➔ Make sure that the USB device is securely connected to the USB jack.
- ➔ Check if the USB device or a cable is damaged.
- ➔ Check if the USB device is on.
- ➔ If the USB device is connected via a USB hub, connect the USB device directly to the player.

Internet streaming

The picture/sound is poor/certain programmes display a loss of detail, especially during fast-motion or dark scenes.

- ➔ Picture/sound quality may be improved by changing the connection speed. Recommended connection speed is of at least 2.5 Mbps for standard definition video (10 Mbps for high definition video).

There is no options menu during Internet streaming.

- ➔ Options menu is not available during Internet streaming.

Network connection

The player cannot connect to the network.

- ➔ Check the network connection (page 16) and the network settings (page 29).

The PC cannot connect to the Internet after [Wi-Fi Protected Setup™ (WPS)] is performed (BDP-S3700 only).

- ➔ The wireless settings of the router may change automatically if you use the Wi-Fi Protected Setup function before adjusting the settings of the router. In this case, change the wireless settings of your PC accordingly.

You cannot connect the player to the wireless LAN router (BDP-S3700 only).

- ➔ Check if the wireless LAN router is on.
- ➔ Depending on the surrounding environment, such as the wall material, radio wave receiving condition, or obstacles between the player and the wireless LAN router, the communication distance may be shortened. Move the player and the wireless LAN router closer to each other.
- ➔ Devices that use a 2.4 GHz frequency band, such as a microwave, Bluetooth, or digital cordless device, may interrupt the communication. Move the player away from such devices, or turn off such devices.

The desired wireless router do not appear in the wireless network list (BDP-S3700 only).

- ➔ Press RETURN to return to the previous screen, and try wireless setup again. If the desired wireless router is still not detected, select [New connection registration] to perform [Manual registration].

The message [A new software version is available. Please go to the “Setup” section of the menu and select “Software Update” to perform the update.] appears on the screen when turning the player on.

- ➔ See [Software Update] (page 24) to update the player to a newer software version.

Control for HDMI (BRAVIA Sync)

The [Control for HDMI] function does not work (BRAVIA Sync).

- ➔ Check that [Control for HDMI] in [HDMI Settings] is set to [On] (page 28).
- ➔ If you change the HDMI connection, turn the player off and on again.
- ➔ If power failure occurs, set [Control for HDMI] in [HDMI Settings] to [Off], then set [Control for HDMI] in [HDMI Settings] to [On] (page 28).
- ➔ Check the following and refer to the instruction manual supplied with the component.
 - the connected component is compatible with the [Control for HDMI] function.
 - the connected component’s setting for the [Control for HDMI] function is correct.

- ➔ When you connect the player to a TV through an AV amplifier (receiver),
 - if the AV amplifier (receiver) is not compatible with the [Control for HDMI] function, you may be unable to control the TV from the player.
 - if you change the HDMI connection, disconnect and reconnect the mains lead, or a power failure occurs, try the following:
 - ① Switch the input selector of the AV amplifier (receiver) so that the picture from the player appears on the TV screen.
 - ② Set [Control for HDMI] in [HDMI Settings] to [Off], then set [Control for HDMI] in [HDMI Settings] to [On] (page 28). Refer to the instruction manual supplied with the AV amplifier (receiver).

The System Power-Off function does not work (BRAVIA Sync).

- ➔ Check that [Control for HDMI] and [Linked to TV-off] in [HDMI Settings] are set to [On] and [Valid] (page 28).

Others

Playback does not start from the beginning of content.

- ➔ Press **OPTIONS**, and select [Play from start].

Playback does not start from the resume point where you last stopped playing.

- ➔ The resume point may be cleared from memory depending on the disc when
 - you open the disc tray.
 - you disconnect the USB device.
 - you play other content.
 - you turn off the player.

Message Code 1 [Playback stopped. The content being played is protected by Cinavia and is not authorized for playback on this device. For more information, see <http://www.cinavia.com>. Message Code 1.] appears on the screen when playing a disc.

- ➔ The audio track of the video that you are playing contains a Cinavia code indicating it was intended for presentation using professional equipment only and is not authorised for playback by consumers (page 5).

The disc tray does not open and you cannot remove the disc even after you press **▲.**

- ➔ While the player is turned on, press **■** (stop), **HOME**, and then **TOP MENU** button on the remote to unlock the tray and disable the Child Lock (page 11).
- ➔ Try the following:
 - ① Turn the player off, and disconnect the mains lead.
 - ② Reconnect the mains lead while pressing down **▲** on the player.
 - ③ Keep pressing down **▲** on the player until the tray opens.
 - ④ Remove the disc.
 - ⑤ Disconnect and reconnect the mains lead again to recover the player.

The message [[EJECT] Key is currently unavailable.] appears on the screen after **▲ (open/close) is pressed.**

- ➔ Contact your nearest Sony dealer or local authorised Sony service facility.

The player does not respond to any button.

- ➔ Moisture has condensed inside the player (page 4).

Specifications

Specifications and design are subject to change without notice.

System

Laser: Semiconductor laser

Inputs and outputs

(Jack name:

Jack type/Output level/Load impedance)

DIGITAL OUT (COAXIAL):

Phono jack/0.5 V_{p-p}/75 ohms

HDMI OUT:

HDMI 19-pin standard connector

LAN (100):

100BASE-TX Terminal

USB:

USB jack Type A (For connecting a USB memory, memory card reader, digital still camera, and digital video camera)*

* Do not use for power charging purposes.

DC IN:

BDP-S3700: 12 V DC, 650 mA

BDP-S1700: 12 V DC, 600 mA

Wireless (BDP-S3700 only)

Wireless LAN standard:

Protocol IEEE 802.11 b/g/n

Frequency range / Output Power

2,400 - 2,483.5 MHz / 19.98 dBm

Channels 1-13

Modulation:

DSSS and OFDM

General

Power requirements:

12 V DC with AC adaptor

Rating: Input 220 V - 240 V AC,
50/60 Hz

Power consumption (when using AC adaptor):

BDP-S3700: 9.2 W

BDP-S1700: 8.5 W

Network standby:

0.8 W (all wired/wireless network ports ON)

Dimensions (approx.):

230 mm × 194 mm × 39 mm
(width/depth/height)
incl. projecting parts

Mass (approx.): 0.8 kg

Operating temperature:

5 °C to 35 °C

Operating humidity:

25 % to 80 %

Supplied accessories

- AC adaptor (AC-L1210WW) (1)
- AC power cord (mains lead) (1)
- Remote commander (remote) (1)
- R03 (size AAA) batteries (2)

Playable discs

Blu-ray Disc *1	BD-ROM BD-R*2/BD-RE*2
DVD *3	DVD-ROM DVD-R/DVD-RW DVD+R/DVD+RW
CD *3	CD-DA (Music CD) CD-ROM CD-R/CD-RW

*1 Since the Blu-ray Disc specifications are new and evolving, some discs may not be playable depending on the disc type and the version.

The audio output differs depending on the source, connected output jack, and selected audio settings.

*2 BD-RE: Ver.2.1

BD-R: Ver.1.1, 1.2, 1.3 including organic pigment type BD-R (LTH type)

The BD-Rs recorded on a PC cannot be played if postscripts are recordable.

*3 A CD or DVD disc will not play if it has not been correctly finalised. For more information, refer to the instruction manual supplied with the recording device.

Discs that cannot be played

- BDs with cartridge
- BDXLs
- DVD-RAMs
- HD DVDs
- DVD Audio discs
- PHOTO CDs
- Data part of CD-Extras
- Super VCDs
- Audio material side on DualDiscs

Note on Discs

This product is designed to playback discs that conform to the Compact Disc (CD) standard. DualDiscs and some of the music discs encoded with copyright protection technologies do not conform to the Compact Disc (CD) standard, therefore, these discs may not be playable by this product.

Note on playback operations of BDs/DVDs

Some playback operations of BDs/DVDs may be intentionally set by software producers. Since this player plays BDs/DVDs according to the disc contents the software producers designed, some playback features may not be available.

Note about double-layer BDs/DVDs

The playback pictures and sound may be momentarily interrupted when the layers switch.

Region code (BD-ROM/DVD VIDEO only)

Your player has a region code printed on the bottom of the unit and will only play BD-ROMs/DVD VIDEOS labeled with identical region codes or .

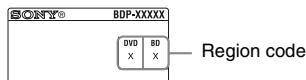

Playable types of files

Video

Codec	Container	Extension	With Audio
MPEG-1 Video* ¹	PS	.mpg, .mpeg	Dolby Digital, DTS, LPCM, MPEG
	MKV	.mkv	Dolby Digital, LPCM, AAC, MP3, Vorbis
MPEG-2 Video* ²	PS* ³	.mpg, .mpeg	Dolby Digital, DTS, LPCM, MPEG
	TS* ⁴	.m2ts, .mts	Dolby Digital, DTS, LPCM, MPEG, AAC
	MKV* ¹	.mkv	Dolby Digital, LPCM, AAC, MP3, Vorbis
Xvid	AVI	.avi	Dolby Digital, LPCM, WMA9, MP3
	MKV	.mkv	Dolby Digital, LPCM, AAC, MP3, Vorbis
MPEG4/AVC* ⁵	MKV* ¹	.mkv	Dolby Digital, LPCM, AAC, MP3, Vorbis
	MP4* ¹	.mp4, .m4v	AAC
	TS* ¹	.m2ts, .mts	Dolby Digital, DTS, LPCM, MPEG, AAC
	Quick Time* ⁶	.mov	Dolby Digital, LPCM, AAC, MP3
	FLV* ⁶	.flv, .f4v	LPCM, AAC, MP3
	3gpp/3gpp2* ⁶	.3gp, .3g2, .3gpp, .3gp2	AAC
VC1* ¹	TS	.m2ts, .mts	Dolby Digital, DTS, LPCM, MPEG, AAC
	MKV	.mkv	Dolby Digital, LPCM, AAC, MP3, Vorbis
WMV9* ^{1*7}	ASF	.wmv, .asf	WMA9, WMA 10 Pro
	MKV	.mkv	Dolby Digital, LPCM, AAC, MP3, Vorbis
Motion JPEG* ⁶	Quick Time	.mov	Dolby Digital, LPCM, AAC, MP3
	AVI	.avi	Dolby Digital, LPCM, AAC, MP3

Format

AVCHD (Ver.2.0)*^{1*8*9}

Music

Codec	Extension
MP3 (MPEG-1 Audio Layer III) ^{*10}	.mp3
AAC/HE-AAC ^{*1*10}	.m4a, .aac ^{*6}
WMA9 Standard ^{*1}	.wma
WMA 10 Pro ^{*11}	.wma
LPCM ^{*10}	.wav
FLAC ^{*1}	.flac, .fla
Dolby Digital ^{*6*10}	.ac3
DSF ^{*1}	.dsf
DSDIFF ^{*1*12}	.dff
AIFF ^{*1}	.aiff, .aif
ALAC ^{*1}	.m4a
Vorbis	.ogg
Monkey's Audio	.ape

Photo

Format	Extension
JPEG	.jpeg, .jpg, .jpe
PNG	.png ^{*13}
GIF	.gif ^{*13}
BMP	.bmp ^{*6*14}

^{*1} The player may not play this file format on a DLNA server (BDP-S3700 only).

^{*2} The player can only play standard definition video on a DLNA server (BDP-S3700 only).

^{*3} The player does not play DTS format files on a DLNA server (BDP-S3700 only).

^{*4} The player can only play Dolby Digital format files on a DLNA server (BDP-S3700 only).

^{*5} The player can support AVC up to Level 4.1.

^{*6} The player does not play this file format on a DLNA server (BDP-S3700 only).

^{*7} The player can support WMV9 up to Advance Profile.

^{*8} The player can support frame rate up to 60 fps.

^{*9} The player plays AVCHD format files that are recorded on a digital video camera, etc. The AVCHD format disc will not play if it has not been correctly finalised.

^{*10} The player can play “.mka” files. (This file cannot be played on a DLNA server (BDP-S3700 only).)

^{*11} The player does not play coded file such as Lossless.

^{*12} The player does not play DST encoded files.

^{*13} The player does not play animated PNG or animated GIF files.

^{*14} The player does not support 16bit BMP files.



- Some files may not play depending on the file format, file encoding, recording condition, or DLNA server condition (BDP-S3700 only).
- Some files edited on a PC may not play.
- Some files may not be able to perform fast forward or fast reverse function.
- The player does not play coded files such as DRM.
- The player can recognise the following files or folders in BDs, DVDs, CDs and USB devices:
 - up to folders in the 9th layer, including the root folder.
 - up to 500 files/folders in a single layer.
- The player can recognise the following files or folders stored in the DLNA server (BDP-S3700 only):
 - up to folders in the 19th layer.
 - up to 999 files/folders in a single layer.
- The player can support frame rate:
 - up to 60 fps for AVCHD (MPEG4/AVC) only.
 - up to 30 fps for other video codecs.
- The player can support video bit rate up to 40 Mbps.
- Some USB devices may not work with this player.

- The player can recognise Mass Storage Class (MSC) devices (such as flash memory or an HDD), Still Image Capture Device (SICD) class devices and I01 keyboard.
- To avoid data corruption or damage to the USB memory or devices, turn off the player when connecting or removing the USB memory or devices.
- The player may not play high bit rate video files on DATA CDs smoothly. It is recommended to play such files using DATA DVDs or DATA BDs.

About wireless LAN security (BDP-S3700 only)

Since communication via the wireless LAN function is established by radio waves, the wireless signal may be susceptible to interception. To protect wireless communication, this player supports various security functions. Be sure to correctly configure the security settings in accordance with your network environment.

◆ No Security

Although you can easily make settings, anyone can intercept wireless communication or intrude into your wireless network, even without any sophisticated tools. Keep in mind that there is a risk of unauthorised access or interception of data.

◆ WEP

WEP applies security to communications to prevent outsiders from intercepting communications or intruding into your wireless network. WEP is a legacy security technology that enables older devices, which do not support TKIP/AES, to be connected.

◆ WPA-PSK (TKIP), WPA2-PSK (TKIP)

TKIP is a security technology developed to correct the deficiencies of WEP. TKIP assures a higher security level than WEP.

◆ WPA-PSK (AES), WPA2-PSK (AES)

AES is a security technology that uses an advanced security method that is distinct from WEP and TKIP.

AES assures a higher security level than WEP or TKIP.

Notes About the Discs

- To keep the disc clean, handle the disc by its edge. Do not touch the surface.
 

Dust, fingerprints, or scratches on the disc may cause it to malfunction.
- Do not expose the disc to direct sunlight or heat sources such as hot air ducts, or leave it in a car parked in direct sunlight as the temperature may rise considerably inside the car.
- After playing, store the disc in its case.
- Clean the disc with a cleaning cloth. Wipe the disc from the centre out.
 
- Do not use solvents such as benzine, thinner, commercially available disc/lens cleaners, or anti-static spray intended for vinyl LPs.
- If you have printed the disc's label, dry the label before playing.

- Do not use the following discs.
 - A lens cleaning disc.
 - A disc that has a non-standard shape (e.g., card, heart).
 - A disc with a label or sticker on it.
 - A disc that has cellophane tape or sticker adhesive on it.
- Do not resurface the playing side of a disc to remove surface scratches.

Language code list

For details, see [BD/DVD Viewing Settings] (page 27).

The language spellings conform to the ISO 639: 1988 (E/F) standard.

Code Language

1027	Afar	1028	Abkhazian
1032	Afrikaans	1039	Amharic
1044	Arabic	1045	Assamese
1051	Aymara	1052	Azerbaijani
1053	Bashkir	1057	Byelorussian
1059	Bulgarian	1060	Bihari
1061	Bislama	1066	Bengali
1067	Tibetan	1070	Breton
1079	Catalan	1093	Corsican
1097	Czech	1103	Welsh
1105	Danish	1109	German
1130	Bhutani; Dzongkha	1142	Greek
1144	English	1145	Esperanto
1149	Spanish	1150	Estonian
1151	Basque	1157	Persian
1165	Finnish	1166	Fiji
1171	Faroese	1174	French
1181	Frisian	1183	Irish
1186	Scots Gaelic	1194	Galician
1196	Guarani	1203	Gujarati
1209	Hausa	1217	Hindi
1226	Croatian	1229	Hungarian
1233	Armenian	1235	Interlingua
1239	Interlingue	1245	Inupiak
1248	Indonesian	1253	Icelandic
1254	Italian	1257	Hebrew
1261	Japanese	1269	Yiddish
1283	Javanese	1287	Georgian
1297	Kazakh	1298	Greenlandic; Kalaallisut
1299	Cambodian; Khmer	1300	Kannada
1301	Korean	1305	Kashmiri
1307	Kurdish	1311	Kirghiz
1313	Latin	1326	Lingala
1327	Laothian; Lao	1332	Lithuanian
1334	Latvian	1345	Malagasy
1347	Maori	1349	Macedonian
1350	Malayalam	1352	Mongolian
1353	Moldavian	1356	Marathi

Code Language

1357	Malay	1358	Malese; Maltese
1363	Burmese	1365	Nauru
1369	Nepali	1376	Dutch
1379	Norwegian	1393	Occitan
1403	Oromo	1408	Oriya
1417	Punjabi; Panjabi	1428	Polish
1435	Pashto; Pushto	1436	Portuguese
1463	Quechua	1481	Rhaeto- Romance
1482	Kirundi; Rundi	1483	Romanian
1489	Russian	1491	Kinyarwanda
1495	Sanskrit	1498	Sindhi
1501	Sangho; Sango	1502	Serbo- Croatian
1503	Singhalese; Sinhalese	1505	Slovak
1506	Slovenian	1507	Samoan
1508	Shona	1509	Somali
1511	Albanian	1512	Serbian
1513	Siswati; Swati	1514	Sesotho; Sotho southern
1515	Sundanese	1516	Swedish
1517	Swahili	1521	Tamil
1525	Telugu	1527	Tajik
1528	Thai	1529	Tigrinya
1531	Turkmen	1532	Tagalog
1534	Setswana; Tswana	1535	Tonga; Tonga islands
1538	Turkish	1539	Tsonga
1540	Tatar	1543	Twi
1557	Ukrainian	1564	Urdu
1572	Uzbek	1581	Vietnamese
1587	Volapük	1613	Wolof
1632	Xhosa	1665	Yoruba
1684	Chinese	1697	Zulu
1703	Not specified		

Parental control/area code

For details, see [Parental Control Area Code] (page 27).

Code Area

2044	Argentina	2047	Australia
2046	Austria	2057	Belgium
2070	Brazil	2090	Chile
2092	China	2093	Colombia
2115	Denmark	2165	Finland
2174	France	2109	Germany
2200	Greece	2219	Hong Kong
2248	India	2238	Indonesia
2239	Ireland	2254	Italy
2276	Japan	2304	Korea
2333	Luxembourg	2363	Malaysia
2362	Mexico	2376	Netherlands
2390	New Zealand	2379	Norway
2427	Pakistan	2424	Philippines
2428	Poland	2436	Portugal
2489	Russia	2501	Singapore
2149	Spain	2499	Sweden
2086	Switzerland	2543	Taiwan
2528	Thailand	2184	United Kingdom
2586	Vietnam		

The software of this player may be updated in the future. To download any available updates and the Operating Instructions with advanced features, please visit the following website:

www.sony.eu/support

 To find out useful hints, tips and information about Sony products and services please visit: www.sony.eu/myproducts/



HDMI



<http://www.sony.net/>