

# DENON<sup>®</sup>

## DCD-900NE

COMPACT DISC PLAYER

# Owner's Manual

[Front panel](#)[Display](#)[Rear panel](#)[Remote](#)[Index](#)

<b>Accessories</b>	<b>4</b>
Inserting the batteries	5
Operating range of the remote control unit	5
<b>Part names and functions</b>	<b>6</b>
Front panel	6
Display	8
Rear panel	9
Remote control unit	10

## Connections

<b>Connecting an amplifier</b>	<b>16</b>
<b>Connecting to a device with digital audio input connectors</b>	<b>17</b>
<b>Connecting a USB flash drive to the USB port</b>	<b>18</b>
<b>Connecting an external control device</b>	<b>19</b>
<b>Connecting the timer device</b>	<b>20</b>
<b>Connecting the power cord</b>	<b>21</b>

## Playback

<b>Basic operation</b>	<b>23</b>
Turning the power on	23
Switching the power to standby	23
Selecting the playback media mode	24
Switching the display's brightness	24
Switching the pure direct mode	25
<b>Playing CDs</b>	<b>26</b>
Playing CDs	26
Playing tracks in a specific order (Program playback)	28
<b>Playing DATA CDs</b>	<b>29</b>
Playing files	30
<b>Playing a USB flash drive</b>	<b>32</b>
Playing files stored on USB flash drives	33
<b>Using the timer play function</b>	<b>35</b>



## Settings

Setting the Auto Standby mode	36
-------------------------------	----

## Tips

Tips	38
------	----

Troubleshooting	39
-----------------	----

Power does not turn on / Power is turned off	40
--	----

Operations cannot be performed through the remote control unit	41
--	----

Display on this unit shows nothing	41
------------------------------------	----

No sound comes out	42
--------------------	----

Sound is interrupted or noise occurs	42
--------------------------------------	----

Cannot playback Discs	43
-----------------------	----

USB flash drives cannot be played back	44
--	----

## Appendix

Playing back Discs	45
--------------------	----

Files	45
-------	----

Playing back a USB flash drives	47
---------------------------------	----

Playback order of music files	48
-------------------------------	----

About folders and files	49
-------------------------	----

Cautions on using media	50
-------------------------	----

Loading discs	50
---------------	----

How to handle media	51
---------------------	----

Cleaning discs	51
----------------	----

Explanation of terms	52
----------------------	----

Specifications	55
----------------	----



Index	58
-------	----



Thank you for purchasing this Denon product. To ensure proper operation, please read this owner's manual carefully before using the product. After reading this manual, be sure to keep it for future reference.

## Accessories

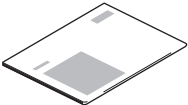
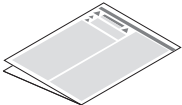
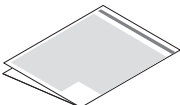
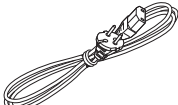
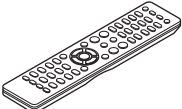
Check that the following parts are supplied with the product.

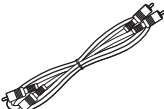
 Quick Start Guide	 Safety Instructions	 Cautions on Using Batteries	 Power cord
 Remote control unit (RC-1246)	 2x R03/AAA batteries	 Audio cable	



## Inserting the batteries

- 1 Remove the rear lid in the direction of the arrow and remove it.



- 2 Insert two batteries correctly into the battery compartment as indicated.

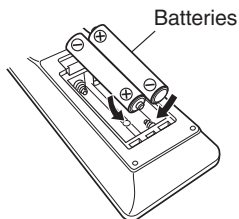

- 3 Put the rear cover back on.

### NOTE

- To prevent damage or leakage of battery fluid:
  - Do not use a new battery together with an old one.
  - Do not use two different types of batteries.
- Remove the batteries from the remote control unit if it will not be in use for long periods.
- If the battery fluid should leak, carefully wipe the fluid off the inside of the battery compartment and insert new batteries.

## Operating range of the remote control unit

Point the remote control unit at the remote sensor when operating it.

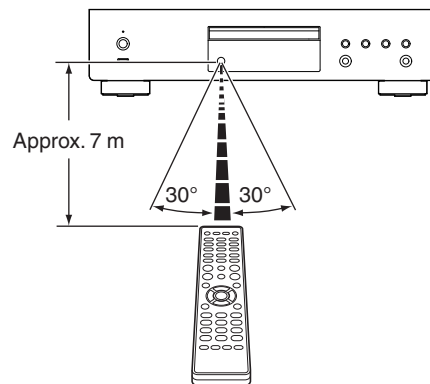

## Part names and functions

### Front panel

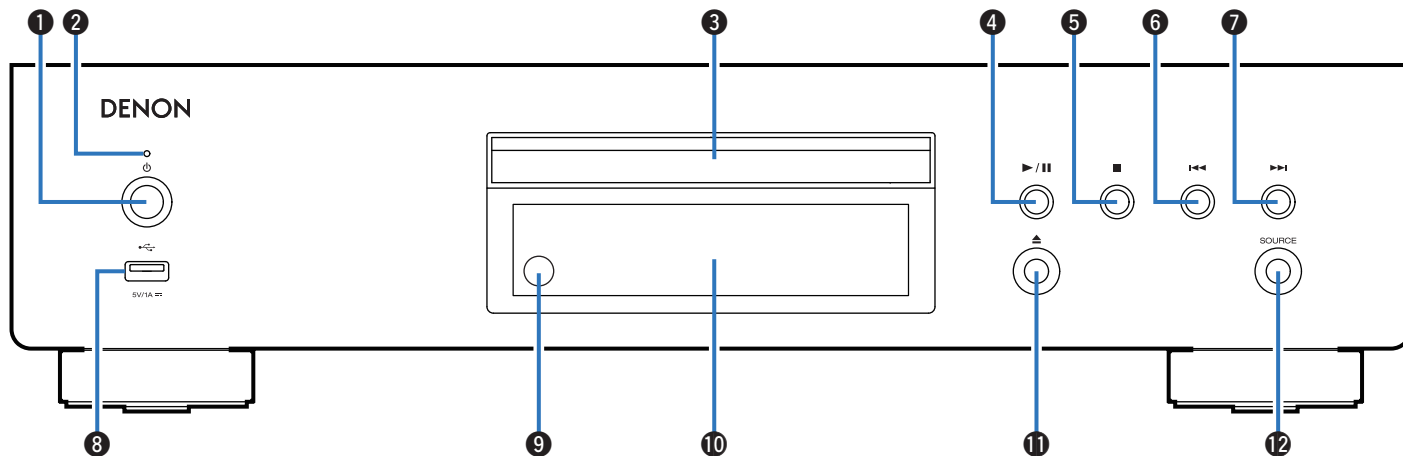

For details, see the next page.



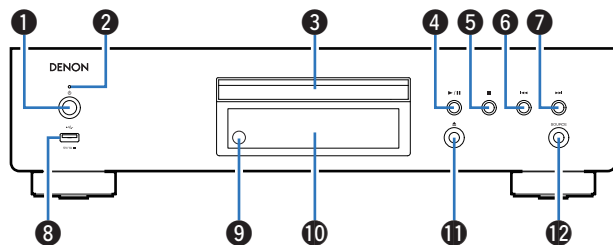

### 1 Power $\phi$ button

This turns the power on/off (standby). (☞ p. 23)

### 2 Power indicator

This is lit as follows according to the power status:

- Power on : Green
- Standby : Off

### 3 Disc tray

Used to insert a disc.

### 4 Play/Pause button (▶/||)

Plays the track/Pauses the track.

### 5 Stop button (■)

Stops playback.

### 6 Reverse-skip button (◀◀)

Returns to the start of the currently playing track.

### 7 Forward-skip button (▶▶)

Plays the next track.

### 8 USB port (🔌)

This is used to connect USB storages (such as USB flash drives).  
(☞ p. 18)

### 9 Remote control sensor

This receives signals from the remote control unit. (☞ p. 5)

### 10 Display

Various information is displayed here. (☞ p. 8)

### 11 Disc tray open/close button (▲)

Used to open/close the disc tray.

### 12 SOURCE button

Select the media to play back. (☞ p. 24)



## Display

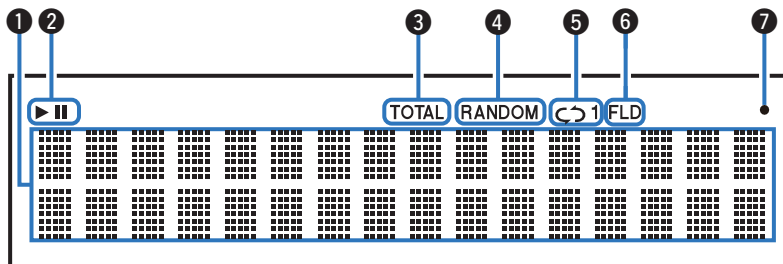

### 1 Information display

Displays various information or playback elapsed time and so on of the disc.

### 2 Playback mode indicators

▶ : Lights up during playback.

|| : Lights up during pause.

### 3 TOTAL indicator

Lights when the total number of tracks and total time of the CD are displayed.

### 4 RANDOM indicator

Lights during random playback.

### 5 Repeat mode indicators

Lights to match the repeat mode settings.

### 6 Folder mode indicator

- Lights up when the folder mode is set in the playback range of the CD-R/CD-RW. (☞ p. 31)

- Lights up when the folder mode is set in the playback range of the USB flash drive. (☞ p. 34)

### 7 Remote control signal reception indicator

Lights when a signal is received from the remote control.





## Rear panel

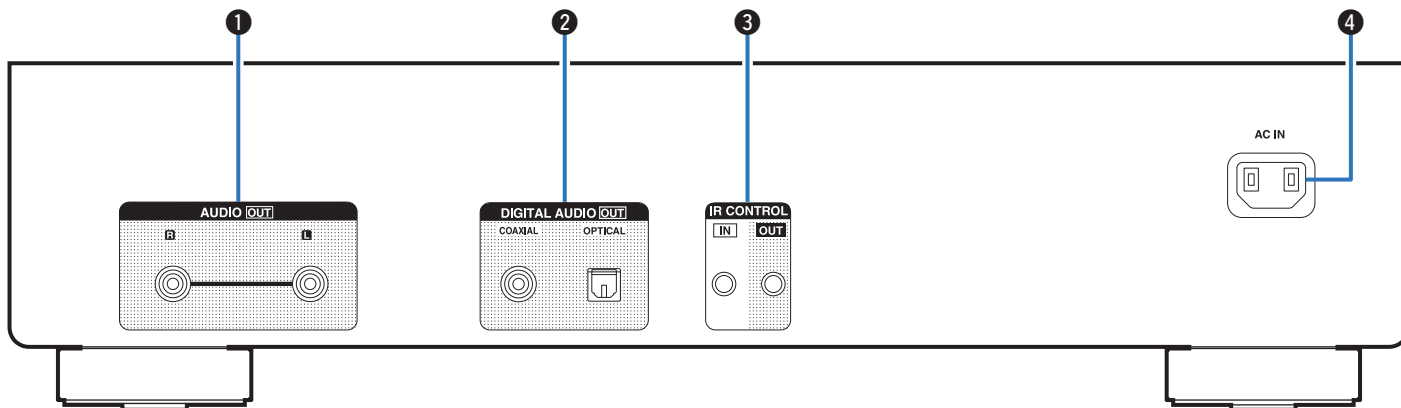

### 1 AUDIO OUT connectors

Used to connect devices equipped with analog audio inputs connectors or an external amplifier. (👉 p. 16)

### 2 DIGITAL AUDIO OUT connectors (COAXIAL/OPTICAL)

Used to connect an amplifier or D/A converter that has a digital input connectors. (👉 p. 17)

### 3 IR CONTROL connectors

Used to connect infrared receivers/transmitters in order to operate this unit and external devices. (👉 p. 19)

### 4 AC inlet (AC IN)

Used to connect the power cord. (👉 p. 21)



## Remote control unit

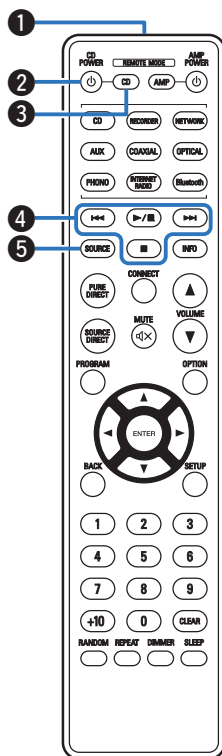

The remote control provided with this unit can control a Denon integrated network amplifier.

- “Integrated network amplifier operations” (☞ p. 13)

### ■ Operating this unit

To operate this unit, press REMOTE MODE CD button to switch the remote control operating mode to this unit.

#### 1 Remote control signal transmitter

This transmits signals from the remote control unit. (☞ p. 5)

#### 2 CD POWER button

This turns the power on/off (standby). (☞ p. 23)

#### 3 Remote mode select button (REMOTE MODE CD)

This switches the remote control operating mode to CD player.

#### 4 System buttons

These perform playback related operations.

#### 5 SOURCE button

Select the media to play back. (☞ p. 24)



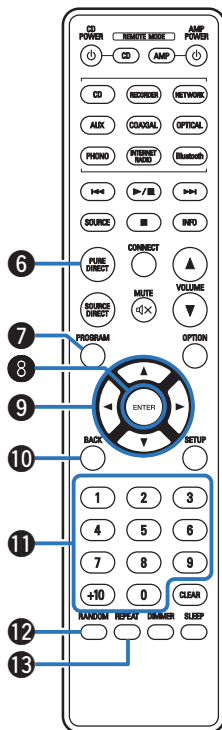

### 6 PURE DIRECT button

Switches the pure direct mode. (👉 p. 25)

### 7 PROGRAM button

This sets program playback. (👉 p. 28)

### 8 ENTER button

This determines the selection.

### 9 Cursor buttons (Δ▽◀▶)

These select items.

### 10 BACK button

Returns to the previous item.

### 11 Number buttons (0 – 9, +10)

These enter numbers into the unit.

### 12 RANDOM button

Switches the random playback.

### 13 REPEAT button

Switches to the repeat playback.



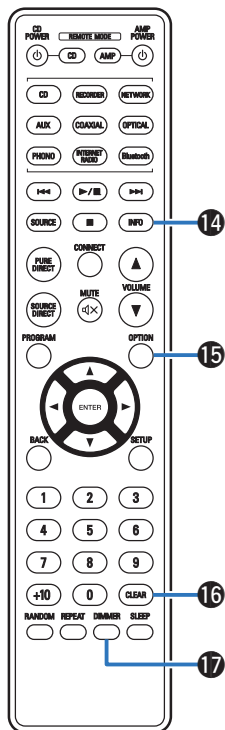

#### 14 Information button (INFO)

This switches the track information shown in the display during playback.

#### 15 OPTION button

- Selects the playback range of the data CD. (☞ p. 31)
- Selects the playback range of the USB flash drive. (☞ p. 34)

#### 16 CLEAR button

This clears the program registration. (☞ p. 28)

#### 17 DIMMER button

This switches the brightness of the display. (☞ p. 24)



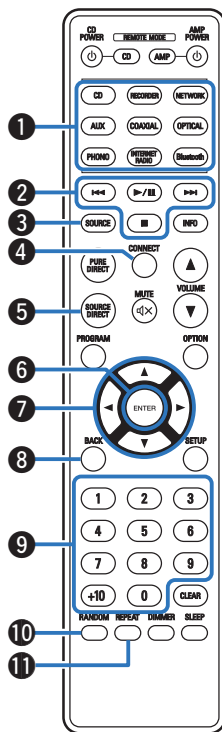

## ■ Integrated network amplifier operations

You can operate a Denon integrated network amplifier.

To operate a Denon integrated network amplifier, press the REMOTE MODE AMP button to switch the remote control to the integrated network amplifier operation mode.

- 1 Input source select buttons
- 2 System buttons
- 3 SOURCE button
- 4 CONNECT button
- 5 SOURCE DIRECT button
- 6 ENTER button
- 7 Cursor buttons ( $\Delta$   $\nabla$   $\triangleleft$   $\triangleright$ )
- 8 BACK button
- 9 Number buttons (0 – 9, +10)
- 10 RANDOM button
- 11 REPEAT button



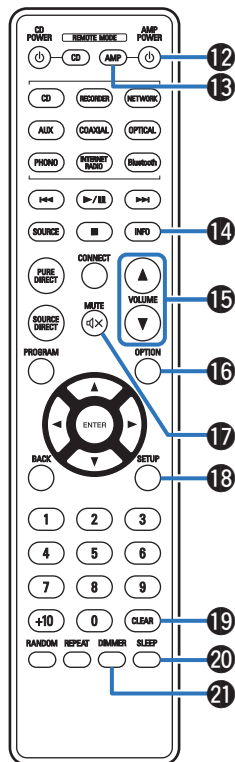

- 12 AMP POWER  $\odot$  button
- 13 Remote mode select button (REMOTE MODE AMP)
- 14 Information button (INFO)
- 15 VOLUME buttons ( $\blacktriangle$ / $\blacktriangledown$ )
- 16 OPTION button
- 17 MUTE button ( $\text{M}$ )
- 18 SETUP button
- 19 CLEAR button
- 20 SLEEP button
- 21 DIMMER button



- The remote control may not operate some products.



## ■ Contents

Connecting an amplifier	16
Connecting to a device with digital audio input connectors	17
Connecting a USB flash drive to the USB port	18
Connecting an external control device	19
Connecting the timer device	20
Connecting the power cord	21

### NOTE

- Do not plug in the power cord until all connections have been completed.
- Do not bundle power cords together with connection cables. Doing so can result in humming or noise.

## ■ Cables used for connections

Provide necessary cables according to the devices you want to connect.

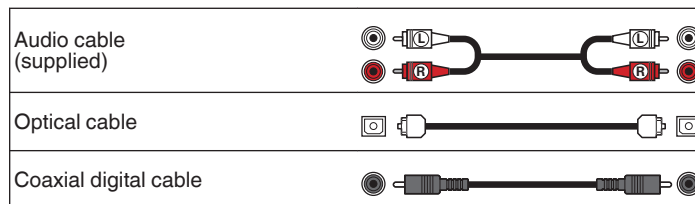

## Connecting an amplifier

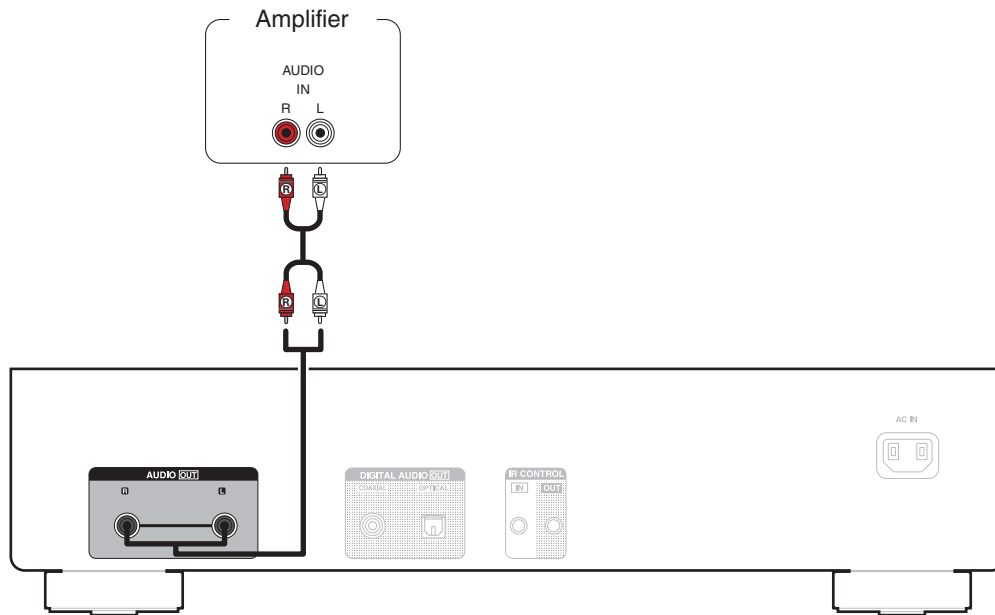



## Connecting to a device with digital audio input connectors

You can enjoy digital audio playback by connecting an amplifier or D/A converter that has a digital audio connector to this unit.

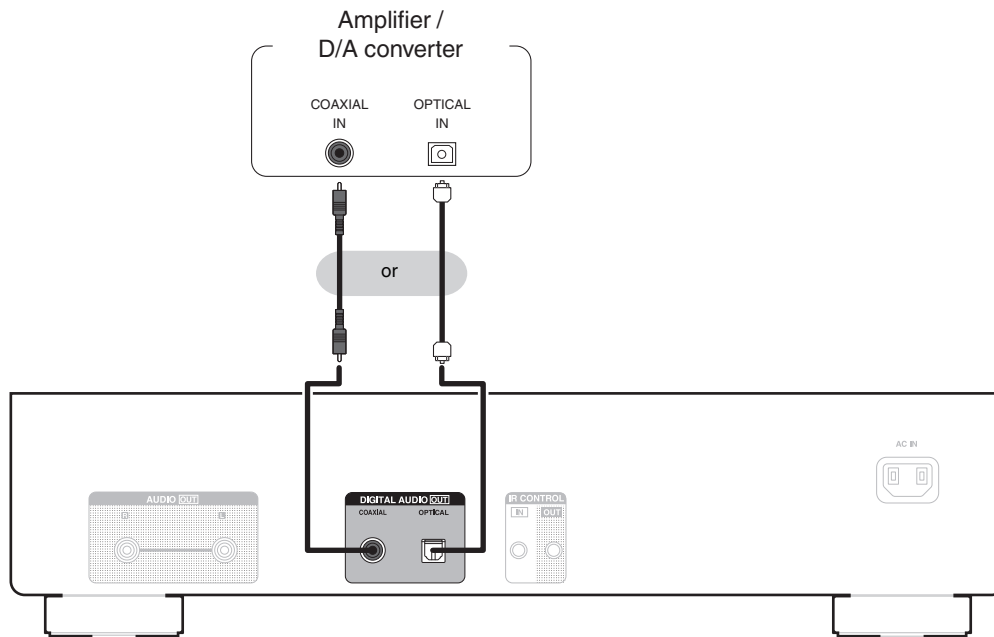

### NOTE

- Digital audio output stops during playback of the DSD files via USB flash drive.
- To connect recorder that has a digital audio connector isn't recommended.



## Connecting a USB flash drive to the USB port

For operating instructions see “Playing a USB flash drive”. (🔍 p. 32)

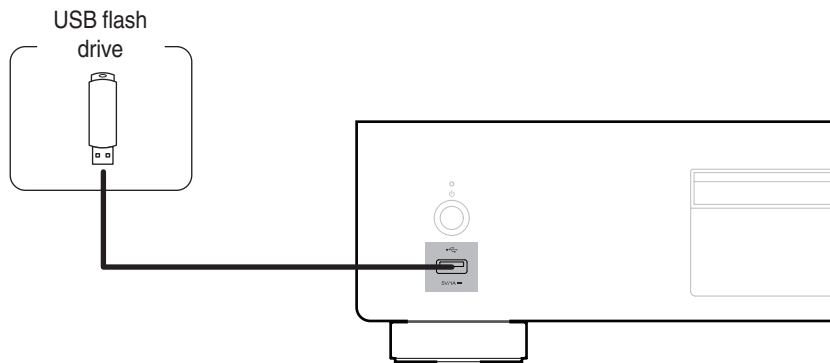

- Denon does not guarantee that all USB flash drives will operate or receive power. When using a portable USB hard disk drive (HDD) which came with an AC adapter, use that device's supplied AC adapter.

### NOTE

- USB flash drives will not work via a USB hub.
- It is not possible to use this unit by connecting the unit's USB port to a PC via a USB cable.
- Do not use an extension cable when connecting a USB flash drive. This may cause radio interference with other devices.



## Connecting an external control device

When this unit is installed in a location where the remote control signals cannot reach (installation in a cabinet etc.), it can still be controlled by the remote control by connecting a remote control receiver unit (sold separately).

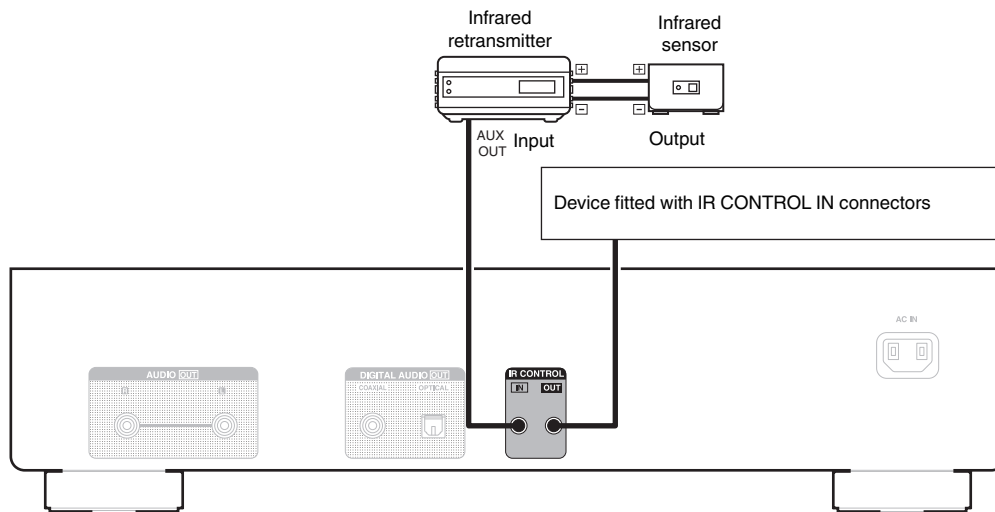

## Connecting the timer device

This unit can perform timer play when an amplifier and timer device are connected to this unit. (“Using the timer play function” (👉 p. 35))

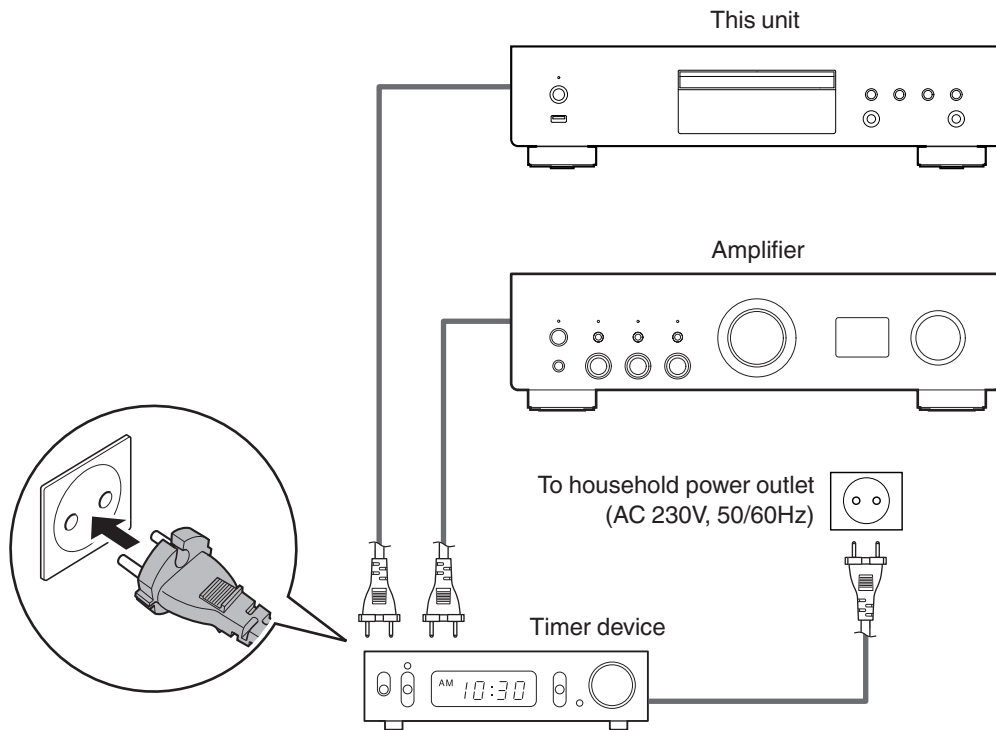

## Connecting the power cord

After completing all the connections, insert the power plug into the power outlet.

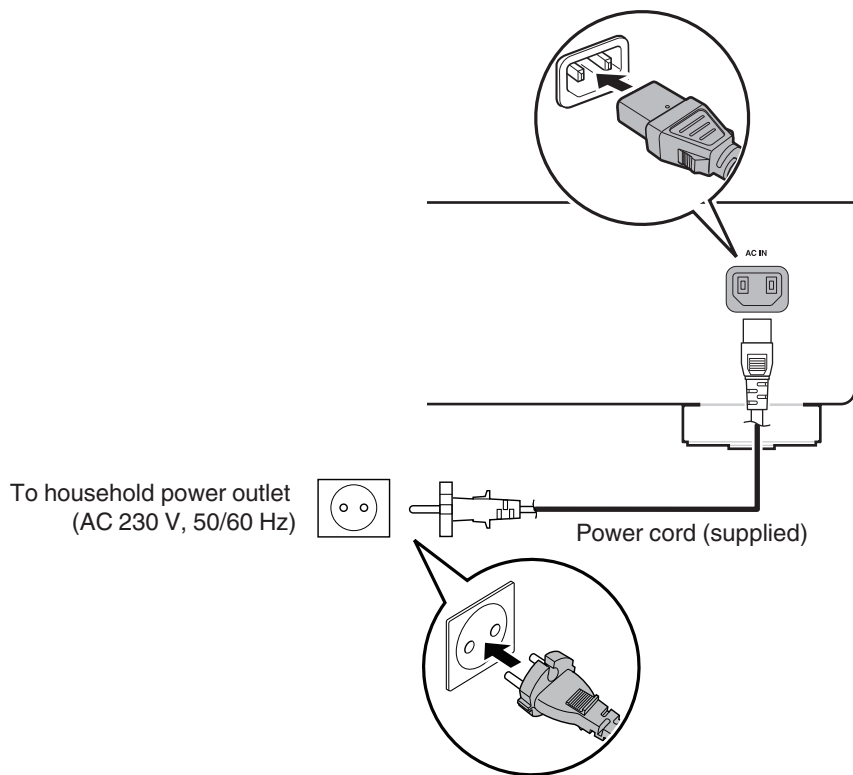

## ■ Contents

Basic operation	23
Playing CDs	26
Playing DATA CDs	29
Playing a USB flash drive	32
Using the timer play function	35



## Basic operation

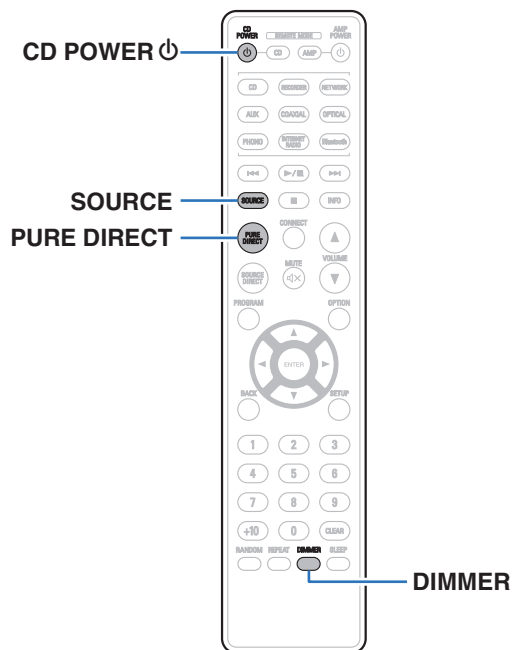

### Turning the power on

- 1 Press **CD POWER**  to turn on power to the unit.  
The power indicator lights green.



- You can also press  on the main unit to turn on power from standby mode.

### Switching the power to standby

- 1 Press **CD POWER** .
- The unit switches to standby mode.



- You can also switch the power to standby by pressing  on the main unit.

#### NOTE

- Power continues to be supplied to some of the circuitry even when the power is in the standby mode. When leaving home for long periods of time or when going on vacation, unplug the power cord from the power outlet.



## Selecting the playback media mode

### 1 Press SOURCE to select the playback media mode.

<b>Disc</b> (Default):	Select to playback a disc.
<b>USB:</b>	Select to playback a USB flash drive.



- You can also select the playback media mode by pressing SOURCE on the main unit.

## Switching the display's brightness

The display brightness can be adjusted between four levels. Switching the display off reduces a source of noise that affects sound quality, enabling higher sound quality playback.

### 1 Press DIMMER.

- The brightness of the display switches each time the button is pressed.



- The display brightness is set to most brightly by default.
- If buttons are operated when the display is off, information is temporarily displayed at the brightest setting.
- The display is only turned off during playback.





## Switching the pure direct mode

In pure direct mode, the display turns off and digital audio output stops. This reduces the source of noise that can adversely affect sound quality, enabling high quality playback.

### 1 Press PURE DIRECT.

The display turned off, and pure direct playback begins.

- Switches the pure direct mode each time the button is pressed.

<b>Pure Direct On Mode1:</b>	Turns off the display and outputs digital audio.
<b>Pure Direct On Mode2:</b>	Turns off the display and stops output of digital audio.
<b>Pure Direct Off (Default):</b>	Disables pure direct mode.



- The display brightness cannot be changed in pure direct mode.
- The display is only turned off during playback.



# Playing CDs

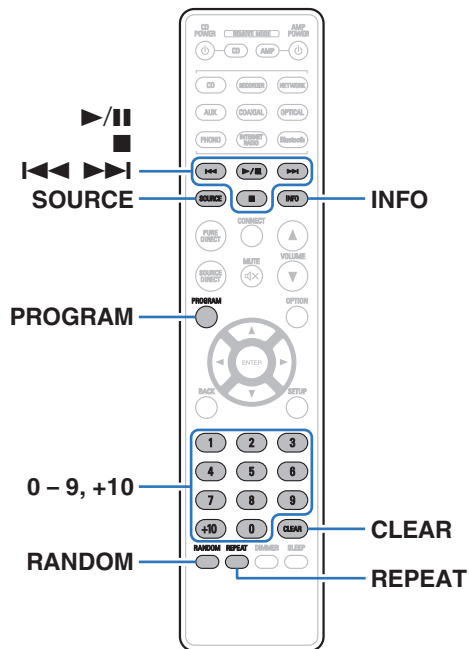

## Playing CDs



- 1 **Insert a disc.** (👉 p. 50)
  - Press **▲** on the main unit to open/close the disc tray.
- 2 **Press SOURCE to select the playback media mode to “Disc”.** (👉 p. 24)
- 3 **Press ►/||.**

The ► indicator lights on the display. Playback starts.

### NOTE

- Do not place any foreign objects in the disc tray. Doing so could damage the unit.
- Do not push the disc tray in by hand when the power is turned off. Doing so could damage the unit.



Operation buttons	Function
	Playback / Pause
	Stop
	Skip to previous track / Skip to next track (Press and hold) Fast-reverse / Fast-forward
<b>0 - 9, +10</b>	Select the track
<b>RANDOM</b>	Random playback
<b>REPEAT</b>	Repeat playback <ul style="list-style-type: none"> <li>Switching between All-track repeat, Single-track repeat and Repeat off.</li> </ul>
<b>INFO</b>	Time display switching <ul style="list-style-type: none"> <li>Switching between elapsed time of the current track, remaining time of the current track and remaining time of all tracks.</li> <li>The time displayed on this unit may differ from this actual time, as it is calculated by truncating to the nearest 1 second.</li> </ul>

## ■ Discs that can be played back

- See "About Playing Back Discs". (📖 p. 45)

## ■ Playing a specific track (Direct searching)

### 1 Use 0 - 9, +10 to select the tracks.

[Example]

Track 4 :

Press number 4 to select track 4.

Track 12 :

Press numbers +10 and 2 consecutively.



## Playing tracks in a specific order (Program playback)

Up to 25 tracks can be programmed.

### 1 In the stop mode, press PROGRAM.

“Program” appears on the display.

### 2 Use 0 – 9, +10 to select the tracks.

[Example]

Track 4 :

Press number 4 to select track 4.

Track 12 :

Press numbers +10 and 2 consecutively.

### 3 Press ►/II.

Playback starts in the programmed order.



- The program is cleared when the disc tray is opened or the power is turned off.
- When RANDOM is pressed during program playback, the programmed tracks are played in random order.
- When REPEAT is pressed during program playback, the tracks are played repeatedly in the programmed order.

## ■ Checking the order of the programmed tracks

In the stop mode, press ►►I.

The tracks are shown in the programmed order in the display each time ►►I is pressed.

## ■ To clear the last track programmed

In the stop mode, press CLEAR.

The last track programmed is cleared each time the button is pressed.



- You can also select a track to be cleared by pressing ►►I.

## ■ Clearing the all programmed track

In the stop mode, press PROGRAM.



## Playing DATA CDs

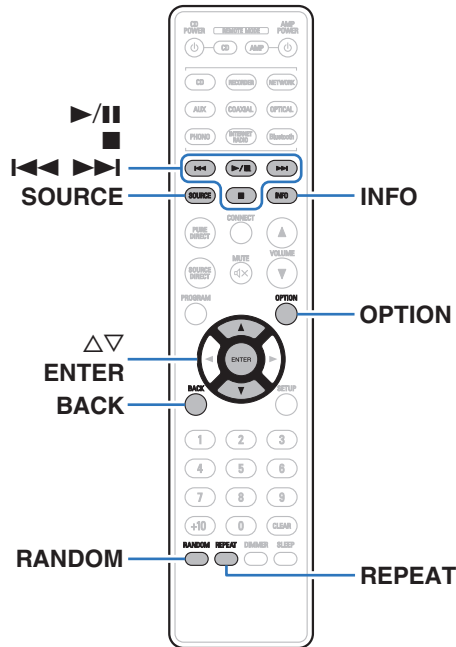

- This section explains how to playback music files that are recorded onto a CD-R or CD-RW.
- There are many music distribution sites on the Internet allowing you to download music files in MP3 or WMA (Windows Media® Audio) format. The music (files) downloaded from such sites can be stored on CD-R/CD-RW discs and played on this unit.
- The audio format types and specifications supported by this unit for playback are as follows.  
See “Playable files” for details. (👉 p. 45)
  - **MP3**
  - **WMA**

### NOTE

- Copyright-protected files cannot be played.
- Note that depending on the software used for burning and other conditions, some files may not play or display correctly.

“Windows Media” and “Windows” are the trademarks or registered trademarks of Microsoft Corporation in the United States and other countries.



## Playing files

- 1 Load a CD-R/CD-RW disc containing music files into the disc tray. (🔑 p. 50)
  - Press ▲ on the main unit to open/close the disc tray.
- 2 Press SOURCE to select the playback media mode to “Disc”. (🔑 p. 24)
- 3 Use Δ∇ to select the music file to be played from the CD-R/CD-RW music data, then press ENTER. Playback starts.

Operation buttons	Function
▶/	Playback / Pause
■	Stop
◀◀▶▶	Skip to previous track / Skip to next track (Press and hold) Fast-reverse / Fast-forward
BACK	Moving up a level in the folder tree
Δ∇	Select the item
ENTER	Enter the selected item / Playback
OPTION	Select the playback range
RANDOM	Random playback
REPEAT	Repeat playback <ul style="list-style-type: none"> <li>• Switching between All-track repeat, Single-track repeat and Repeat off.</li> </ul>
INFO	Switches the display between Title name / Artist name, Title name / Album name and File name.



- To start playing another file during playback of a CD-R/CD-RW, first press BACK to display the file tree. Next, use Δ∇ to select the file to be played and press ENTER.



## ■ Switching the display

During playback, press INFO.

- Switches the display between Title name / Artist name, Title name / Album name and File name.
- If a file does not support text information or no track information is recorded, the file name is displayed.
- The player can display the following characters:

**ABCDEFGHIJKLMNOPQRSTUVWXYZ**

**abcdefghijklmnopqrstuvwxyz**

**0123456789**

**! " # \$ % & ; : < > ? @ \ [ ] \_ ` | { } ~ ^ ' ( ) \* + , - . / = space**

- Any characters that cannot be displayed are replaced with "." (period).
- The folder and file numbers are set automatically when the disc is loaded.

## ■ Switching the playback range

In the stop mode, press OPTION.

- The playback range of a track can be set.

---

### Folder mode:

All the files in the selected folder are played. The "FLD" indicator on the display lights at this time.

---

### All mode:

All the files in the disc are played.

---



## Playing a USB flash drive

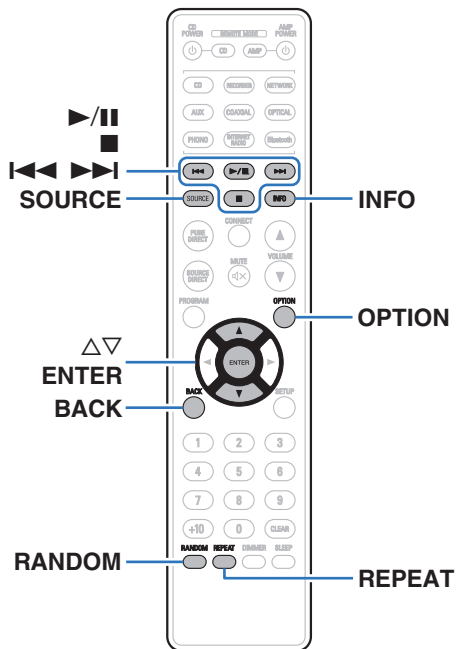



- Playing back music files stored on a USB flash drive.
- Only USB flash drives conforming to mass storage class standards can be played on this unit.
- The audio format types and specifications supported by this unit for playback are as follows.  
For details, see “Playing back a USB flash drives” (👉 p. 47).



- **WMA**
- **MP3**
- **WAV**
- **MPEG-4 AAC**
- **FLAC**
- **Apple Lossless**
- **AIFF**
- **DSD**





## Playing files stored on USB flash drives

- 1** Connect the USB flash drive to the USB port.  
( p. 18)
- 2** Press SOURCE to select the playback media mode to "USB". ( p. 24)
- 3** Use  $\Delta \nabla$  to select the folder to be played, then press ENTER.
- 4** Use  $\Delta \nabla$  to select the file to be played, then press ENTER.  
Playback starts.

Operation buttons	Function
	Playback / Pause
	Stop
	Skip to previous track / Skip to next track (Press and hold) Fast-reverse / Fast-forward
BACK	Moving up a level in the folder tree
$\Delta \nabla$	Select the item
ENTER	Enter the selected item / Playback
OPTION	Select the playback range
RANDOM	Random playback
REPEAT	Repeat playback <ul style="list-style-type: none"> <li>• Switching between All-track repeat, Single-track repeat and Repeat off.</li> </ul>
INFO	Switches the display between Title name / Artist name, Title name / Album name and File name.



- To start playing another file during playback of a USB flash drive, first press BACK to display the file tree. Next, use  $\Delta \nabla$  to select the file to be played and press ENTER.



**NOTE**

- Note that Denon will accept no responsibility whatsoever for any problems arising with the data on a USB flash drive when using this unit in conjunction with the USB flash drive.
- When a USB flash drive is connected to this unit, the unit loads all of the files on the USB flash drive. Loading may take a while if the USB flash drive contains a large number of folders and/or files.

**Switching the playback range**

Press OPTION.

- The playback range of a track can be set.

<b>Folder mode:</b>	All the files in the selected folder are played. The “FLD” indicator on the display lights at this time.
<b>All mode:</b>	All the files in the USB flash drive are played.



## Using the timer play function

**1** Turn on the power of the connected components.  
( p. 20)

**2** Switch the amplifier's function to input from the connected unit.

**3** Press the **OPTION** button on the remote control for 5 seconds or more to turn on the timer play function.

"Timer Play On" is displayed on the display.



- Pressing the **OPTION** button on the remote control for 5 seconds or more switches the timer play function between on and off.
- "Timer Play On" and "Timer Play Off" are only shown on the display when the timer play function switches between on and off.

**4** Insert a disc in this unit or insert a USB flash drive into the USB port.

**5** Switch the media mode of this unit to the media to be played using the timer.

**6** Set the audio timer for the desired times.

- Refer also to the owner's manual of the audio timer.

**7** Turn the timer "On".

- The power of the components connected to the timer turns off.
- When the set time is reached, the power of the different components automatically turns on and playback starts from the first track.



- The timer play does not support the random play or program play.



## Setting the Auto Standby mode

When Auto Standby mode is set to On, if the unit remains in the stopped state and no operations are performed for approximately 15 minutes, the unit automatically switches to standby mode.

Auto Standby mode is set to on by default.

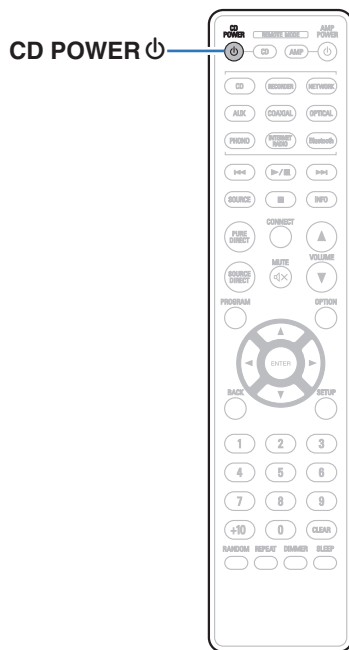

### 1 Press and hold CD POWER for 5 seconds or more to switch it on and off.

The display changes as follows each time it is switched on and off.

- When auto standby mode is on: “Auto Standby On” is displayed.
- When auto standby mode is off: “Auto Standby Off” is displayed.



- You can also switch on and off the auto standby mode by pressing and holding the  on the main unit for 5 seconds or more.



## ■ Contents

### Tips

I want to enjoy analog output audio at higher quality	38
I want to playback just the specified folder	38
I want to randomly play back all tracks on a CD-R/CD-RW or USB flash drive	38
I want to playback high resolution music files	38

### Troubleshooting

Power does not turn on / Power is turned off	40
Operations cannot be performed through the remote control unit	41
Display on this unit shows nothing	41
No sound comes out	42
Sound is interrupted or noise occurs	42
Cannot playback Discs	43
USB flash drives cannot be played back	44



# Tips

---

## I want to enjoy analog output audio at higher quality

- Switch pure direct mode to “Pure Direct On Mode2”. (👉 p. 25)

## I want to playback just the specified folder

- Press the OPTION button to set the playback mode to folder playback mode. (👉 p. 31), (👉 p. 34)

## I want to randomly play back all tracks on a CD-R/CD-RW or USB flash drive

- Before playback, press the OPTION button to set the playback mode to “All Mode”, then press the RANDOM for random playback. (👉 p. 31), (👉 p. 34)

## I want to playback high resolution music files

- This unit can playback high resolution music files that are stored on a USB flash drive. (👉 p. 47)



## Troubleshooting

---

If a problem should arise, first check the following:

1. Are the connections correct?
2. Is the set being operated as described in the owner's manual?
3. Are the other devices operating properly?

If this unit does not operate properly, check the corresponding symptoms in this section.

If the symptoms do not match any of those described here, consult your dealer as it could be due to a fault in this unit. In this case, disconnect the power immediately and contact the store where you purchased this unit.



## Power does not turn on / Power is turned off

### Power is not turned on.

- Check whether the power plug is correctly inserted into the power outlet. (👉 p. 21)
- This unit is in standby mode. Press the CD POWER ⏻ button on the remote control. (👉 p. 23)

### Power automatically turns off.

- The auto standby mode setting is on. The auto standby mode automatically switches the unit to standby if there are no operations for more than 15 minutes. To disable the auto standby mode, press and hold the CD POWER ⏻ button on the remote control for more than 5 seconds when the auto standby mode is enabled. (👉 p. 36)

### The power turns off and the power indicator shows one long blink and three short blinks in red.

- The protection circuit has been activated due to an error in the internal power supply. Unplug and reinsert the power cord, then press the CD POWER ⏻ button to turn on the power again. If the problem is not solved by turning the power off and on again, unplug the power cord and contact our customer service center.





## Operations cannot be performed through the remote control unit

### Operations cannot be performed through the remote control unit.

- Batteries are worn out. Replace with new batteries. (👉 p. 5)
- Operate the remote control unit within a distance of about 7 m from this unit and at an angle of within 30°. (👉 p. 5)
- Remove any obstacle between this unit and the remote control unit.
- Insert the batteries in the proper direction, checking the ⊕ and ⊖ marks. (👉 p. 5)
- The unit's remote control sensor is exposed to strong light (direct sunlight, inverter type fluorescent bulb light, etc.). Move the set to a place in which the remote control sensor will not be exposed to strong light.
- When using a 3D video device, the remote control unit of this unit may not function due to effects of infrared communications between units (such as TV and glasses for 3D viewing). In this case, adjust the direction of units with the 3D communications function and their distance to ensure they do not affect operations from the remote control unit of this unit.
- Press the REMOTE MODE CD button to switch the remote control operating mode to "CD". (👉 p. 10)

## Display on this unit shows nothing

### Display is off.

- Press the DIMMER button, and change the setting to anything other than off. (👉 p. 24)
- When pure direct mode is set to "Pure Direct On Mode1" or "Pure Direct On Mode2", the display turns off. Press the PURE DIRECT button on the remote control to set "Pure Direct Off". (👉 p. 25)



## No sound comes out

### No sound is produced. Or sound is distorted.

- Check the connections for all devices. (👉 p. 15)
- Insert connection cables all the way in.
- Check that input connectors and output connectors are not reversely connected.
- Check cables for damage.
- Check the amplifier's functions and controls and adjust as necessary.
- Digital audio output stops during playback of the DSD files.
- When pure direct mode is set to "Pure Direct On Mode2", digital audio output stops. Set pure direct mode to "Pure Direct Off" or "Pure Direct On Mode1" to output digital audio. (👉 p. 25)

## Sound is interrupted or noise occurs

### During playback from the CD-R/CD-RW, sound is occasionally interrupted.

- This may be caused by poor recording conditions, or the disc itself may be of poor quality. Use a correctly recorded disc.

### During playback from the USB flash drive, sound is occasionally interrupted.

- When the transfer speed of the USB flash drive is slow, sound may occasionally be interrupted.



## Cannot playback Discs

### **Cannot playback when the play button is pressed, or cannot correctly play back a specific part of the disc.**

- The disc is dirty or scratched. Either clean the disc, or insert a different disc. (👉 p. 51)

### **Cannot playback CD-R/CD-RW.**

- Discs cannot be played back unless they have been finalized. Use a finalized disc. (👉 p. 45)
- This may be caused by poor recording conditions, or the disc itself may be of poor quality. Use a correctly recorded disc.
- Files are created in a format that is not supported by this unit. Check the formats supported by this unit. (👉 p. 45)

### **“No Disc” is displayed.**

- “No Disc” is displayed if the disc is loaded upside-down or if no disc is loaded. Check that the disc is loaded label side up.

### **“System Error” is displayed.**

- “System Error” is displayed when an error not caused by disc, format, etc., occurs. Contact our customer service center.

### **“Can't Read Disc” is displayed.**

- “Can't Read Disc” is displayed when the inserted disc cannot be read because it is not compatible with this unit or is dirty or scratched. Check the disc.

### **“Wrong Format” is displayed.**

- “Wrong Format” is displayed for files created in a format that is not supported by this unit. Check the formats supported by this unit. (👉 p. 45)



## USB flash drives cannot be played back

### USB flash drive is not recognized.

- Disconnect and reconnect the USB flash drive. (👉 p. 18)
- Mass storage class compatible USB flash drives are supported.
- This unit does not support a connection through a USB hub. Connect the USB flash drive directly to the USB port.
- The USB flash drive must be formatted to FAT16 or FAT32.
- Not all USB flash drives are guaranteed to work. Some USB flash drives are not recognized. When using a type of portable hard disc drive compatible with the USB connection that requires power from an AC adapter, use the AC adapter that came with the drive.

### Files on the USB flash drive are not displayed.

- Files of a type not supported by this unit are not displayed. (👉 p. 47)
- This unit is able to display files in a maximum of 16 folder layers. A maximum of 255 folders and 65025 files can be stored. Modify the folder structure of the USB flash drive.
- When multiple partitions exist on the USB flash drive, only files on the first partition are displayed.

### iOS and Android devices are not recognized.



- The USB port of this unit does not support playback from iOS and Android devices.

### Files on a USB flash drive cannot be played.

- Files are created in a format that is not supported by this unit. Check the formats supported by this unit. (👉 p. 47)
- You are attempting to play a file that is copyright protected. Files that are copyright protected cannot be played on this unit.
- Playback may not be possible if the album art file size exceeds 2 MB.



## Playing back Discs

Playable media	
CD	
CD-R	
CD-RW	

### NOTE

- Some discs and some recording formats cannot be played.
- Non-finalized discs cannot be played.

## Files

### ■ Specifications of supported files

	Sampling frequency	Bit rate	Extension
<b>MP3</b>	32/44.1/48 kHz	48 – 320 kbps	.mp3
<b>WMA</b>	32/44.1/48 kHz	48 – 320 kbps	.wma

### ■ Maximum number of playable files and folders

Maximum number of folders : 256

Total number of folders and files : 512



**NOTE**

- Be sure to give files the extension. Files with any other extensions or files with no extensions cannot be played.
- Recordings you have made should only be used for your personal enjoyment, and as per copyright laws may not be used in other ways without permission of the copyright holder.



- Only music files that are not copyright-protected can be played on this unit.
  - Content downloaded from pay sites on the Internet are copyright protected. Also, files encoded in WMA format when ripped from a CD, etc. on a computer may be copyright protected, depending on the computer's settings.
- The maximum number of files and folders that can be played differs depending on conditions such as the length of the file name or folder name or the number of levels in the folder hierarchy.



## Playing back a USB flash drives

- This unit is compatible with MP3 ID3-Tag (Ver. 2) standard.
- This unit is compatible with WMA META tags.
- If the image size (pixels) of an album artwork exceeds 500 × 500 (WMA/MP3/Apple Lossless/DSD) or 349 × 349 (MPEG-4 AAC), then music may not be played back properly.

### ■ Specifications of supported files

	Sampling frequency	Bit rate	Extension
WMA*1	32/44.1/48 kHz	48 – 320 kbps	.wma
MP3	32/44.1/48 kHz	48 – 320 kbps	.mp3
WAV	32/44.1/48/88.2/ 96/176.4/192 kHz	–	.wav
MPEG-4 AAC*1	32/44.1/48 kHz	48 – 320 kbps	.aac/.m4a/.mp4
FLAC	32/44.1/48/88.2/ 96/176.4/192 kHz	–	.flac
Apple Lossless*2	32/44.1/48/88.2/96 kHz	–	.m4a
AIFF	32/44.1/48/88.2/ 96/176.4/192 kHz	–	.aif/.aiff
DSD	2.8/5.6 MHz	–	.dsf/.dff

\*1 Only files that are not protected by copyright can be played on this unit.  
Content downloaded from pay sites on the Internet are copyright protected. Also, files encoded in WMA format when ripped from a CD, etc. on a computer may be copyright protected, depending on the computer's settings.

\*2 The Apple Lossless Audio Codec (ALAC) decoder is distributed under the Apache License, Version 2.0 (<http://www.apache.org/licenses/LICENSE-2.0>).



## ■ Maximum number of playable files and folder

The limits on the number of folders and files that can be displayed by this unit are as follows.

Item	Media	USB flash drive
	Number of folder directory levels *1	
Number of folders		255
Number of files*2		65025

\*1 The limited number includes the root folder.

\*2 The allowable number of files may differ according to the USB flash drive capacity and the file size.

### NOTE

- Digital audio output stops during playback of the DSD files.

## Playback order of music files

When there are multiple folders containing music files, the playback order of folders is automatically set when this unit reads the media. Files in each folder are played in alphabetical order of file name.

### CD-R/CD-RW and USB flash drive

For playback of files on CD-R, CD-RW or USB flash drive, files in all folders on the first layer are played first, next on the second layer, then next on the third layer, and so on in this order.



- The playback order displayed on a PC may differ from the actual playback order.
- The playback order with a CD-R/CD-RW may differ, depending on the writing software.
- The playback order may differ from the order in which the folders or files were recorded if you delete or add a folder or file on USB. This occurs because of data recording specifications and is not a malfunction.





## About folders and files

Music files recorded on CD-R/CD-RW and USB flash drive are divided into large segments (folders) and small segments (files).

Files are stored in folders, and folders can be placed for storage in a hierarchy. The unit can recognize up to 16 levels of folders.

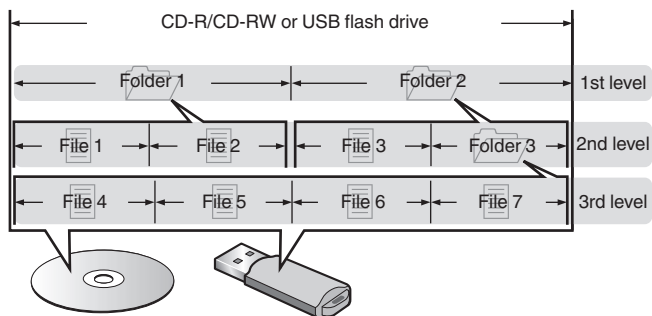

- When writing music files on a CD-R/CD-RW disc, set the writing software's format to "ISO9660". The files may not play properly if they are recorded in other formats. For details, refer to the instructions of your writing software.



## Cautions on using media

### Loading discs

- Set the disc in the tray label side up.
- Make sure the disc tray is fully open when inserting the disc.
- Place the discs flatly, 12 cm discs in the outer tray guide (Figure 1), 8 cm discs in the inner tray guide (Figure 2).

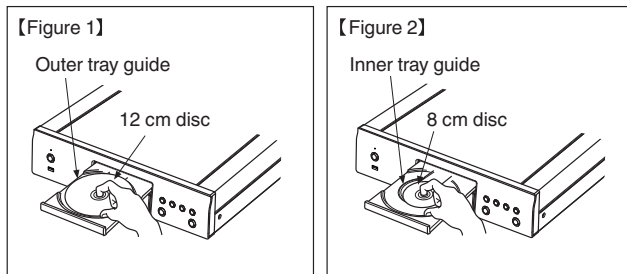

- Place 8 cm discs in the inner tray guide without using an adapter.

#### NOTE

- Only load one disc at a time. Loading two or more discs can damage the unit or scratch the discs.
- Do not use cracked or warped discs or discs that have been repaired with adhesive, etc.
- Do not use discs on which the sticky part of cellophane tape or labels is exposed or on which there are traces of where labels have been removed. Such discs can get caught inside the player and damage it.
- Do not use discs in special shapes, as they may damage the unit.



- Do not push the disc tray in by hand when the power is off. Doing so could damage the unit.
- If the unit is left in a room full of smoke from cigarettes, etc., for long periods of time, the surface of the optical pickup may get dirty, preventing it from receiving signals properly.



## How to handle media

- Do not get fingerprints, oil or dirt on discs.
- Take special care not to scratch discs when removing them from their cases.
- Do not bend or heat discs.
- Do not enlarge the hole in the center.
- Do not write on the labeled (printed) surface with ball-point pens, pencils, etc., or stick new labels on discs.
- Condensation may form on discs if they are moved suddenly from a cold place (outdoors for example) to a warm place, but do not try to dry discs with a hairdryer, etc.
- Do not eject a USB flash drive or turn off the unit while a USB flash drive is being played. This may result in malfunction or loss of the USB flash drive's data.
- Do not attempt to open or modify a USB flash drive.
- USB flash drive and files can be damaged by static electricity. Do not touch the metal contacts of a USB flash drive with your fingers.
- Do not use warped USB flash drive.
- After use, be sure to remove any disc or USB flash drive, and store it in its proper case, to avoid dust, scratches and deformation.
- Do not store discs and USB flash drives in the following places:
  1. Places exposed to direct sunlight for long periods of time
  2. Dusty or humid places
  3. Places exposed to heat from heaters, etc.

## Cleaning discs

- If there are fingerprints or dirt on a disc, wipe them off before using the disc.
- Use a commercially available disc cleaning set or a soft cloth to clean discs.



Gently wipe the disc from the inside towards the outside.

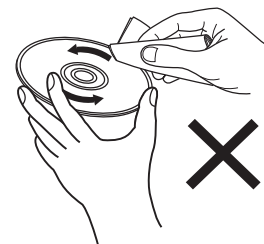

Do not wipe with a circular motion.

### NOTE

- Do not use record spray, antistatic agents, benzene, thinner or other solvents.



## Explanation of terms

---

### Advanced AL32 Processing Plus

Equipped with Advanced AL32 Processing Plus, Denon's own analog waveform reproduction technology. The reproducibility of weak signals is enhanced by expanding 16 bit digital data to 32 bit.

### AIFF (Audio Interchange File Format)

This is an uncompressed and lossless format for digital audio. Use AIFF files to burn high-quality audio CDs from imported songs. AIFF files use approximately 10 MB of disk space per minute.

### Apple Lossless Audio Codec

This is a codec for lossless audio compression method developed by Apple Inc. This codec can be played back on iTunes, iPod or iPhone. Data compressed to approximately 60 – 70 % can be decompressed to exactly the same original data.

### DSD (Direct-Stream Digital)

One of the audio data recording methods, it is the signal aspect used to store audio signals on a super audio CD, and is  $\Delta$ - $\Sigma$  modulated digital audio.

### FLAC (Free Lossless Audio Codec)

FLAC stands for Free lossless Audio Codec, and is a lossless free audio file format. Lossless means that the audio is compressed without any loss in quality.

The FLAC license is as shown below.

Copyright (C) 2000, 2001, 2002, 2003, 2004, 2005, 2006, 2007, 2008, 2009 Josh Coalson

Redistribution and use in source and binary forms, with or without modification, are permitted provided that the following conditions are met:

- Redistributions of source code must retain the above copyright notice, this list of conditions and the following disclaimer.
- Redistributions in binary form must reproduce the above copyright notice, this list of conditions and the following disclaimer in the documentation and/or other materials provided with the distribution.
- Neither the name of the Xiph.org Foundation nor the names of its contributors may be used to endorse or promote products derived from this software without specific prior written permission.



THIS SOFTWARE IS PROVIDED BY THE COPYRIGHT HOLDERS AND CONTRIBUTORS "AS IS" AND ANY EXPRESS OR IMPLIED WARRANTIES, INCLUDING, BUT NOT LIMITED TO, THE IMPLIED WARRANTIES OF MERCHANTABILITY AND FITNESS FOR A PARTICULAR PURPOSE ARE DISCLAIMED. IN NO EVENT SHALL THE FOUNDATION OR CONTRIBUTORS BE LIABLE FOR ANY DIRECT, INDIRECT, INCIDENTAL, SPECIAL, EXEMPLARY, OR CONSEQUENTIAL DAMAGES (INCLUDING, BUT NOT LIMITED TO, PROCUREMENT OF SUBSTITUTE GOODS OR SERVICES; LOSS OF USE, DATA, OR PROFITS; OR BUSINESS INTERRUPTION) HOWEVER CAUSED AND ON ANY THEORY OF LIABILITY, WHETHER IN CONTRACT, STRICT LIABILITY, OR TORT (INCLUDING NEGLIGENCE OR OTHERWISE) ARISING IN ANY WAY OUT OF THE USE OF THIS SOFTWARE, EVEN IF ADVISED OF THE POSSIBILITY OF SUCH DAMAGE.

### MP3 (MPEG Audio Layer-3)

This is an internationally standardized audio data compression scheme, using the "MPEG-1" video compression standard. It compresses the data volume to about one eleventh its original size while maintaining sound quality equivalent to a music CD.

### MPEG (Moving Picture Experts Group), MPEG-2, MPEG-4

These are the names for digital compression format standards used for the encoding of video and audio. Video standards include "MPEG-1 Video", "MPEG-2 Video", "MPEG-4 Visual", "MPEG-4 AVC". Audio standards include "MPEG-1 Audio", "MPEG-2 Audio", "MPEG-4 AAC".

### WMA (Windows Media Audio)

This is audio compression technology developed by Microsoft Corporation.

WMA data can be encoded using Windows Media® Player.

To encode WMA files, only use applications authorized by Microsoft Corporation. If you use an unauthorized application, the file may not work properly.

### Sampling frequency

Sampling involves taking a reading of a sound wave (analog signal) at regular intervals and expressing the height of the wave at each reading in digitized format (producing a digital signal).

The number of readings taken in one second is called the "sampling frequency". The larger the value, the closer the reproduced sound is to the original.



**Dynamic range**

The difference between the maximum undistorted sound level and the minimum discernible level above the noise emitted by the device.

**Bit rate**

This is the amount of audio data recorded on a disc that is read in one second.

**Finalizing**

This process enables DVD/CD recorded with a recorder to be played by other players.

**Linear PCM**

This is an uncompressed PCM (Pulse Code Modulation) signal. Unlike lossy compression audio sources such as MP3, no audio quality or dynamic range deteriorates.



# Specifications

## ■ Audio section

### • Analog output

	[PCM]	[DSD]
<b>Channels:</b>	2-channel	2-channel
<b>Playable frequency range:</b>	2 Hz – 96 kHz (sampling frequency: 192 kHz) 2 Hz – 20 kHz (sampling frequency: 44.1 kHz)	2 Hz – 100 kHz
<b>Playable frequency response:</b>	2 Hz – 50 kHz (-3 dB) (sampling frequency: 192 kHz) 2 Hz – 20 kHz (sampling frequency: 44.1 kHz)	2 Hz – 50 kHz (-3 dB)
<b>S/N:</b>	115 dB	110 dB (Audible range)
<b>Dynamic range:</b>	110 dB (24 bits) 101 dB (16 bits)	108 dB (Audible range)
<b>Harmonic distortion:</b>	0.0020 % (24 bits) 0.0025 % (16 bits)	0.0015 % (Audible range)
<b>Output level:</b>	2.2 V RMS	2.2 V RMS



- **Optical readout system**

<b>Laser:</b>	AlGaAs
<b>Wave length:</b>	780 nm
<b>Signal type:</b>	16-bit linear PCM
<b>Sampling frequency:</b>	44.1 kHz

- **Digital output**

<b>Coaxial:</b>	0.5 Vp-p / 75 $\Omega$ /ohms
<b>Optical :</b>	-15 – -21 dBm

- **Digital input**

<b>USB:</b>	USB Type A (USB 2.0 High speed)
-------------	---------------------------------

## ■ General

<b>Operating temperature:</b>	+5 °C - +35 °C
<b>Power supply:</b>	AC 230 V, 50/60 Hz
<b>Power consumption:</b>	24 W
<b>Power consumption in standby mode:</b>	0.3 W

For the purpose of improvement, the specifications and design are subject to change without notice.





## ■ Dimensions (Unit : mm)

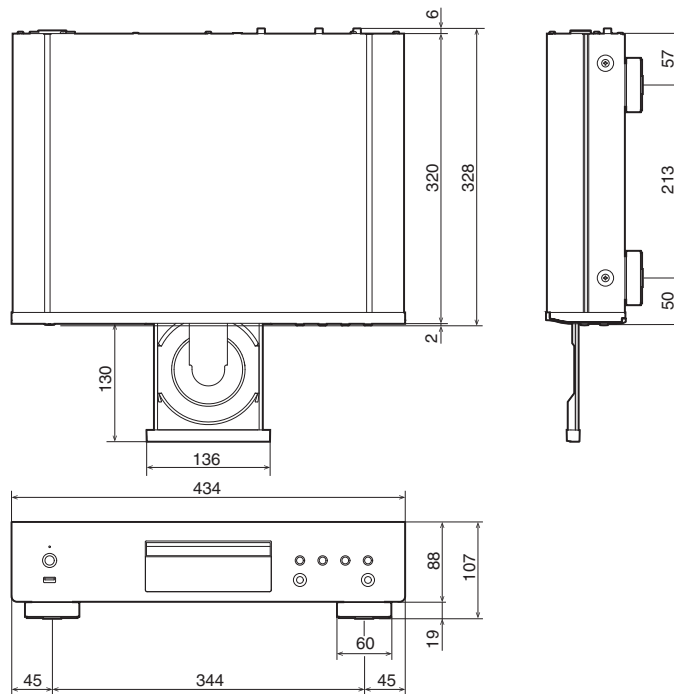

## ■ Weight : 4.9 kg

# Index

## A

Amplifier ..... 16, 17  
 Auto Standby ..... 36

## C

CD ..... 26

## D

D/A converter ..... 17  
 DATA CD ..... 29  
 Display ..... 8  
 Display's brightness ..... 24

## F

Front panel ..... 6

## P

Program playback ..... 28

## R

Rear panel ..... 9  
 Remote control unit ..... 10

## T

Timer device ..... 20, 35  
 Tips ..... 38  
 Troubleshooting ..... 39

## U

USB flash drive ..... 18, 32



**DENON<sup>®</sup>**

[www.denon.com](http://www.denon.com)

3520 10835 00ASA

© 2022 Sound United. All Rights Reserved.