



UAB

**Front Surround System**

**YAS-207**

**YAS-CU207  
NS-WSW42**

**Owner's Manual**

**EN**

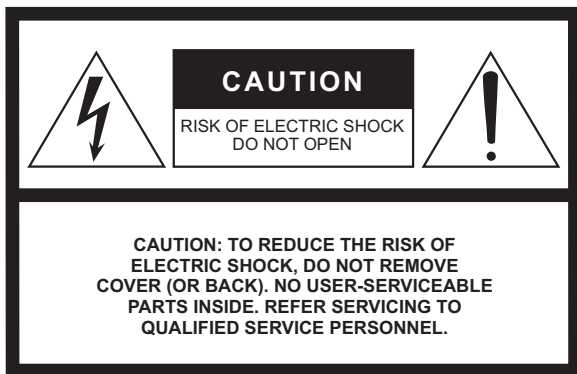

The above warning is located on the bottom or rear of the unit.

## Explanation of Graphical Symbols



The lightning flash with arrowhead symbol within an equilateral triangle is intended to alert the user to the presence of uninsulated “dangerous voltage” within the product’s enclosure that may be of sufficient magnitude to constitute a risk of electric shock to persons.



The exclamation point within an equilateral triangle is intended to alert the user to the presence of important operating and maintenance (servicing) instructions in the literature accompanying the product.

# IMPORTANT SAFETY INSTRUCTIONS

- 1 Read these instructions.
- 2 Keep these instructions.
- 3 Heed all warnings.
- 4 Follow all instructions.
- 5 Do not use this apparatus near water.
- 6 Clean only with dry cloth.
- 7 Do not block any ventilation openings. Install in accordance with the manufacturer’s instructions.
- 8 Do not install near any heat sources such as radiators, heat registers, stoves, or other apparatus (including amplifiers) that produce heat.
- 9 Do not defeat the safety purpose of the polarized or grounding-type plug. A polarized plug has two blades with one wider than the other. A grounding type plug has two blades and a third grounding prong. The wide blade or the third prong are provided for your safety. If the provided plug does not fit into your outlet, consult an electrician for replacement of the obsolete outlet.
- 10 Protect the power cord from being walked on or pinched particularly at plugs, convenience receptacles, and the point where they exit from the apparatus.
- 11 Only use attachments/accessories specified by the manufacturer.
- 12 Use only with the cart, stand, tripod, bracket, or table specified by the manufacturer, or sold with the apparatus. When a cart is used, use caution when moving the cart/apparatus combination to avoid injury from tip-over.
- 13 Unplug this apparatus during lightning storms or when unused for long periods of time.
- 14 Refer all servicing to qualified service personnel. Servicing is required when the apparatus has been damaged in any way, such as power-supply cord or plug is damaged, liquid has been spilled or objects have fallen into the apparatus, the apparatus has been exposed to rain or moisture, does not operate normally, or has been dropped.



### WARNING

TO REDUCE THE RISK OF FIRE OR ELECTRIC SHOCK, DO NOT EXPOSE THIS APPARATUS TO RAIN OR MOISTURE.

(UL60065\_03)

## FCC INFORMATION (U.S.A.)

### 1. IMPORTANT NOTICE: DO NOT MODIFY THIS UNIT!

This product, when installed as indicated in the instructions contained in this manual, meets FCC requirements. Modifications not expressly approved by Yamaha may void your authority, granted by the FCC, to use the product.

### 2. IMPORTANT:

When connecting this product to accessories and/or another product use only high quality shielded cables. Cable/s supplied with this product **MUST** be used. Follow all installation instructions. Failure to follow instructions could void your FCC authorization to use this product in the USA.

### 3. NOTE:

This product has been tested and found to comply with the requirements listed in FCC Regulations, Part 15 for Class "B" digital devices. Compliance with these requirements provides a reasonable level of assurance that your use of this product in a residential environment will not result in harmful interference with other electronic devices. This equipment generates/uses radio frequencies and, if not installed and used according to the instructions found in the users manual, may cause interference harmful to the operation of other electronic devices. Compliance with FCC regulations does not guarantee that interference will not occur in all installations. If this product is found to be the source of interference, which can be determined by turning the unit "OFF" and "ON", please try to eliminate the problem by using one of the following measures:  
Relocate either this product or the device that is being affected by the interference. Utilize power outlets that are on different branch (circuit breaker or fuse) circuits or install AC line filter/s.

In the case of radio or TV interference, relocate/reorient the antenna. If the antenna lead-in is 300 ohm ribbon lead, change the lead-in to co-axial type cable. If these corrective measures do not produce satisfactory results, please contact the local retailer authorized to distribute this type of product. If you can not locate the appropriate retailer, please contact Yamaha Corporation of America, Electronic Service Division, 6600 Orangethorpe Ave, Buena Park, CA90620  
The above statements apply **ONLY** to those products distributed by Yamaha Corporation of America or its subsidiaries.

\* This applies only to products distributed by YAMAHA CORPORATION OF AMERICA.

## FCC/IC NOTICE (U.S.A. and Canada)

- This equipment complies with FCC/IC radiation exposure limits set forth for an uncontrolled environment and meets the FCC radio frequency (RF) Exposure Guidelines and RSS-102 of the IC radio frequency (RF) Exposure rules. This equipment has very low levels of RF energy that it deemed to comply without maximum permissive exposure evaluation (MPE). But it is desirable that it should be installed and operated with at least 20 cm and more between the radiator and person's body.
- This device complies with Part 15 of FCC Rules and Industry Canada license-exempt RSS standard(s). Operation is subject to the following two conditions: (1) this device may not cause interference, and (2) this device must accept any interference, including interference that may cause undesired operation of this device.
- This transmitter must not be co-located or operated in conjunction with any other antenna or transmitter.

This product contains a battery that contains perchlorate material.  
Perchlorate Material—special handling may apply,  
See [www.dtsc.ca.gov/hazardouswaste/perchlorate](http://www.dtsc.ca.gov/hazardouswaste/perchlorate).

The model number, serial number, power requirements, etc., may be found on or near the name plate, which is at the bottom of the unit. You should note this serial number in the space provided below and retain this manual as a permanent record of your purchase to aid identification in the event of theft.

**Model No.**

---

**Serial No.**

---

(Perchlorate/Ser.No)

\* This applies only to products distributed by YAMAHA CORPORATION OF AMERICA.

**CAN ICES-3 (B)/NMB-3(B)** (can-b-02)

### SIMPLIFIED EU DECLARATION OF CONFORMITY

Hereby, Yamaha Music Europe GmbH declares that the radio equipment type [YAS-207] is in compliance with Directive 2014/53/EU. The full text of the EU declaration of conformity is available at the following internet address:  
<https://europe.yamaha.com/en/support/compliance/doc.html>

\* This applies only to products distributed by Yamaha Music Europe GmbH.

# PRECAUTIONS

**PLEASE READ CAREFULLY BEFORE USE. BE SURE TO FOLLOW THESE INSTRUCTIONS.**

**The precautions listed below are to prevent risk of harm to the user and others, as well as to prevent property damage, and to help the user use this unit properly and safely. Be sure to follow these instructions.**

After reading this manual, be sure to keep it in a safe place where it can be referenced at any time.

- Be sure to request inspections or repairs from the dealer where you purchased the unit or from qualified Yamaha service personnel.
- Yamaha cannot be held responsible for injury to you or damage of the products caused by improper use or modifications to the unit.
- This product is for ordinary homes. Do not use for applications requiring high reliability, such as managing lives, health care or high-value assets.



## WARNING

**This content indicates “risk of serious injury or death.”**

### Power supply/power cord

- Do not do anything that could damage the power cord.
  - Do not place it near a heater.
  - Do not bend it excessively or alter it.
  - Do not scratch it.
  - Do not place it under a heavy object.
- Using the power cord with the core of the cord exposed could cause electric shocks or a fire.
- Do not touch the power plug or cord if there is a chance of lightning. Failure to observe this may cause electric shocks.
- Use this unit with the power supply voltage printed on it. Failure to connect to an appropriate AC outlet may cause a fire, electric shocks, or malfunctions.
- Be sure to use the supplied AC power cord. Also, do not use the supplied power cord for other units. Failure to observe the above may cause a fire, burns, or malfunctions.
- Check the electric plug periodically and remove any dirt or dust which may have accumulated on it. Failure to observe this may cause a fire or electric shocks.
- When setting up the unit, make sure that the AC outlet you are using is easily accessible. If some trouble or malfunction occurs, immediately turn off the power switch and disconnect the plug from the AC outlet. Even when the power switch is turned off, as long as the power cord is not unplugged from the wall AC outlet, the unit will not be disconnected from the power source.
- If you hear thunder or suspect approaching lightning, quickly turn off the power switch and pull the power plug from the AC outlet. Failure to observe this may cause a fire or malfunctions.
- If not using the unit for long periods of time, be sure to pull the power plug from the AC outlet. Failure to observe this may cause a fire or malfunctions.

## Do not disassemble

---

- Do not disassemble or modify this unit. Failure to observe this may cause a fire, electric shocks, injury, or malfunctions. If you notice any irregularities, be sure to request an inspection or repair from the dealer where you purchased the unit or from qualified Yamaha service personnel.

## Water warning

---

- Do not expose the unit to rain, use it near water or in damp or wet conditions, or place on it any containers (such as vases, bottles or glasses) containing liquids which might spill into any openings or places where water may drop. A liquid such as water getting into the unit may cause a fire, electric shocks, or malfunctions. If any liquid such as water seeps into the device, turn off the power immediately and unplug the power cord from the AC outlet. Then, request an inspection from the dealer where you purchased the unit or from qualified Yamaha service personnel.
- Never insert or remove an electric plug with wet hands. Do not handle this unit with wet hands. Failure to observe this may cause electric shocks or malfunctions.

## Fire warning

---

- Do not place any burning items or open flames near the unit, since they may cause a fire.

## Installation

---

- Install in the manner instructed in the manual. Falling or toppling may result in injury or damage.
- Once the unit is installed, the security of the installation should be checked on a regular basis. Failure to do so may cause the unit to fall or topple, resulting in injury or damage.

## Battery use

---



### WARNING

#### DO NOT INGEST BATTERY, CHEMICAL BURN HAZARD

The remote control supplied with this product contains a coin/button cell battery. If the coin/button cell battery is swallowed, it can cause severe internal burns in just 2 hours and can lead to death.

Keep new and used batteries away from children. If the battery compartment does not close securely, stop using the product and keep it away from children.

If you think batteries might have been swallowed or placed inside any part of the body, seek immediate medical attention.

- Do not disassemble a battery. If the contents of the battery get on your hands or in your eyes, it can cause blindness or chemical burns.
- Do not dispose of batteries in fire. Doing so may result in the battery bursting, causing a fire or injury.
- Do not expose a battery to high temperatures, such as direct sunlight or a fire. The battery may burst, causing a fire or injury.
- Do not attempt to recharge batteries that are not intended to be charged. Charging could cause the battery to burst or leak, which can cause blindness, chemical burns, or injury.
- If the batteries do leak, avoid contact with the leaked fluid. If the battery fluid should come in contact with your eyes, mouth, or skin, wash immediately with water and consult a doctor. Battery fluid is corrosive and may possibly cause loss of sight or chemical burns.

## Wireless unit

---

- Do not use this unit near medical devices or inside medical facilities. Radio waves from this unit may affect electro-medical devices.
- Do not use this unit within 15 cm (6 in) of persons with a heart pacemaker implant or a defibrillator implant. Radio waves from this unit may affect electro-medical devices, such as a heart pacemaker implant or defibrillator implant.

## If you notice any abnormality

---

- If any of the following abnormalities occur, immediately turn off the power and disconnect the power plug.
  - The power cord/plug is damaged.
  - An unusual smell or smoke is emitted from the unit.
  - Foreign material gets into the interior of the unit.
  - There is a loss of sound during use.
  - There is a crack or damage in the unit.

Continued use could cause electric shocks, a fire, or malfunctions. Immediately request an inspection or repair from the dealer where you purchased the unit or from qualified Yamaha service personnel.

- Be careful not to drop or apply strong impact to this unit. If you suspect the unit may have been damaged due to dropping or impact, immediately turn off the power and pull the power plug from the AC outlet. Failure to observe this may cause electric shocks, a fire, or malfunctions. Immediately request an inspection from the dealer where you purchased the unit or from qualified Yamaha service personnel.



---

This content indicates “risk of injury.”

## Power supply/power cord

---

- Do not use an AC outlet where the power plug fits loosely when inserted. Failure to observe this may cause a fire, electric shocks, or burns.
- When removing the electric plug from the unit or an AC outlet, always hold the plug itself and not the cord. Pulling by the cord can damage it and cause electric shocks or a fire.
- Insert the power plug firmly all the way into the AC outlet. Using the unit when it is not plugged in sufficiently can cause dust to accumulate on the plug, causing a fire or burns.

## Installation

---

- Do not place the unit in an unstable position where it might accidentally drop or fall over and cause injuries.
- Do not block this unit's ventilation holes (cooling slits). This unit has ventilation holes on the bottom to prevent the internal temperature from becoming too high. Failure to observe this may trap heat inside the unit, causing a fire or malfunctions.
- When installing this unit:
  - Do not cover it with any cloth.
  - Do not install it on a carpet or rug.
  - Make sure the top surface faces up; do not install on its sides or upside down.
  - Do not use the device in a confined, poorly-ventilated location.Failure to observe the above may trap heat inside the unit, causing a fire or malfunctions. Ensure that there is adequate space:
  - around the center unit: at least 10 cm (4 in) on top, 10 cm (4 in) on the sides, and 10 cm (4 in) on the rear,
  - around the subwoofer: at least 20 cm (8 in) on top, 20 cm (8 in) on the sides, and 20 cm (8 in) on the rear.
- Do not place the unit in a location where it may come into contact with corrosive gases or salt air or places that have excessive smoke or steam. Doing so may result in malfunction.
- Avoid being near the unit during a disaster, such as an earthquake. Since the unit may turn over or fall and cause injury, quickly move away from the unit and go to a safe place.

- Before moving this unit, be sure to turn off the power switch and disconnect all connection cables. Failure to observe this may damage the cables or cause you or someone else to trip and fall.
- Be sure to request that the dealer where you purchased the unit or qualified service personnel mounts the unit on a wall. The unit could fall and cause injury. Installation requires special skills and experience.

## Hearing loss

---

- Do not use the unit for a long period of time at a high or uncomfortable volume level, since this can cause permanent hearing loss. If you experience any hearing loss or ringing in the ears, consult a physician.
- Before connecting the unit to other devices, turn off the power for all devices. Also, before turning the power of all devices on or off, make sure that all volume levels are set to the minimum. Failing to do so may result in hearing loss, electric shock, or device damage.
- When turning on the AC power in your audio system, always turn on the unit LAST, to avoid hearing loss and speaker damage. When turning the power off, the unit should be turned off FIRST for the same reason. Failure to observe the above may cause hearing impairment or speaker damage.

## Maintenance

---

- Remove the power plug from the AC outlet before cleaning the unit. Failure to observe this may cause electric shocks.

## Handling caution

---

- Do not insert your hand or fingers into the bass reflex port on the front of the subwoofer. Failure to observe this may cause injury.
- Do not insert foreign materials such as metal or paper into the ventilation holes/ bass reflex port (on the front of the subwoofer) of this unit. Failure to observe this may cause a fire, electric shocks, or malfunctions. If foreign material gets into the unit, immediately shut off the power and pull the power plug from the AC outlet and request an inspection from the dealer where you purchased the unit or from qualified Yamaha service personnel.
- Keep small parts out of the reach of infants. Your children may accidentally swallow them.

- Do not do the following:
  - stand on or sit on the equipment.
  - put heavy items on top of the equipment.
  - place the equipment in a stack.
  - apply unreasonable force to buttons, switches, input/output terminals, etc.
  - hang on the equipment.
  - lean against the equipment.
- Avoid pulling the connected cables to prevent injuries or damage to the unit by causing it to fall.
- Do not operate the unit if the sound is distorting. Prolonged use in this condition could cause overheating and result in fire.

## Battery use

---

- Risk of explosion if battery is incorrectly replaced. Replace only with the same equivalent type.
- Do not use batteries other than specified batteries. Doing so cause fire, burns, or inflammation due to leakage.
- Do not put in a pocket or bag, carry, or store batteries together with pieces of metal. The battery could short, burst, or leak, causing a fire or injury.
- Always make sure all batteries are inserted in conformity with the +/- polarity markings. Failure to do so might result in a fire, burns, or inflammation due to fluid leaks.
- When the batteries run out, or if the unit is not to be used for a long time remove the batteries from the remote control to prevent possible leakage of the battery fluid.
- When storing or discarding batteries, insulate the terminal area by applying tape, or some other protection. Mixing them with other batteries or metal objects can cause a fire, burns, or inflammation due to fluid.

# Notice

---

**Indicates points that you must observe in order to prevent product failure, damage or malfunction and data loss, as well as to protect the environment.**

## Power / power cord

---

- If not using the unit for a long period of time, be sure to pull the power plug from the outlet. Even if the ⏻ (Power) has been turned off (indicators are turned off), a minute current is still flowing.

## Installation

---

- Do not use this unit in the vicinity of other electronic equipment, such as a TV, radio, AV unit, or mobile phone. Failure to observe this may cause this unit or the TV or radio to produce noise.
- Do not use this unit in a location that is exposed to direct sunlight, that becomes extremely hot, such as near a heater, or extremely cold, or that is subject to excessive dust or vibration. Failure to observe this may cause the unit's panel to become deformed, the internal components to malfunction, or for operation to become unstable.
- Install this unit as far away from other electronic equipment as possible. Digital signals from this unit may interfere with other electronic equipment.
- If using a wireless network, avoid installing this unit near metal walls or desks, microwave ovens, or other wireless network devices. Obstructions could shorten the transmission distance.

## Connections

---

- If connecting external units, be sure to thoroughly read the manual for each unit and connect them in accordance with the instructions. Failure to properly handle a unit in accordance with the instructions could cause malfunctions.
- Do not connect this unit to industrial units. Digital audio interface standards for consumer use and industrial use are different. This unit has been designed to connect to a consumer-use digital audio interface. Connections to an industrial-use digital audio interface could not only cause this unit to malfunction, but could also damage the speakers.

## Handling

---

- Do not place vinyl, plastic, or rubber products on this unit. Failure to observe this may cause discoloration or deformation in the panel of this unit.
- If the ambient temperature changes drastically (such as during unit transportation or under rapid heating or cooling) and there is a chance condensation may have formed in the unit, leave the unit for several hours without turning on the power until it is completely dry before use. Using the unit while there is condensation can cause malfunctions.

## Maintenance

---

- If the temperature or humidity changes drastically, water droplets (condensation) may form on the unit surface. If water droplets form, immediately wipe them off with a soft cloth. If water droplets are left on the unit, they may be absorbed into the wooden parts, causing deformation.
- When cleaning the unit, use a dry, soft cloth. Using chemicals such as benzene or thinner, cleaning agents, or chemical scrubbing cloths can cause discoloration or deformation.



## About disposal

- Be sure to discard used batteries in accordance with local regulations.

### Information for users on collection and disposal of old equipment and used batteries:



These symbols on the products, packaging, and/or accompanying documents mean that used electrical and electronic products and batteries should not be mixed with general household waste. For proper treatment, recovery and recycling of old products and used batteries, please take them to applicable collection points, in accordance with your national legislation.



By disposing of these products and batteries correctly, you will help to save valuable resources and prevent any potential negative effects on human health and the environment which could otherwise arise from inappropriate waste handling.



For more information about collection and recycling of old products and batteries, please contact your local municipality, your waste disposal service or the point of sale where you purchased the items.

**Pb**

#### For business users in the European Union:

If you wish to discard electrical and electronic equipment, please contact your dealer or supplier for further information.

#### Information on Disposal in other Countries outside the European Union:

These symbols are only valid in the European Union. If you wish to discard these items, please contact your local authorities or dealer and ask for the correct method of disposal.

#### Note for the battery symbol (bottom two symbol examples):

This symbol might be used in combination with a chemical symbol. In this case it complies with the requirement set by the EU Battery Directive for the chemical involved.

(weee\_battery\_eu\_en\_02)

## Information

Indicates information of note regarding this product.

### Functions included in the unit

- Air may be blown out from the bass reflex port. This is not a malfunction. This occurs particularly often when outputting music with heavy bass.

### About the name plate of the unit

The model number, serial number, power requirements, etc., may be found on or near the name plate, which is at the bottom of the unit.

You should note this serial number in the space provided below and retain this manual as a permanent record of your purchase to aid identification in the event of theft.

**Model No.**

---

**Serial No.**

---

(bottom\_en\_01)

## Trademarks

---



The Bluetooth® word mark and logos are registered trademarks owned by Bluetooth SIG, Inc. and any use of such marks by Yamaha Corporation is under license.



Manufactured under license from Dolby Laboratories. Dolby, Dolby Audio, Pro Logic, and the double-D symbol are trademarks of Dolby Laboratories.



For DTS patents, see <http://patents.dts.com>. Manufactured under license from DTS, Inc. DTS, the Symbol, DTS and the Symbol together, DTS Digital Surround, and DTS Virtual:X are registered trademarks or trademarks of DTS, Inc. in the United States and/or other countries. © DTS, Inc. All Rights Reserved.

### HDMI

The terms HDMI, the HDMI Logo, and High-Definition Multimedia Interface are trademarks or registered trademarks of HDMI Licensing LLC in the United States and other countries.

### Blu-ray

“Blu-ray Disc™”, “Blu-ray™”, and the logos are trademarks of the Blu-ray Disc Association.



“Made for iPod,” “Made for iPhone,” and “Made for iPad” mean that an electronic accessory has been designed to connect specifically to iPod, iPhone, or iPad, respectively, and has been certified by the developer to meet Apple performance standards. Apple is not responsible for the operation of this device or its compliance with safety and regulatory standards. Please note that the use of this accessory with iPod, iPhone, or iPad may affect wireless performance.

## About content in this manual

---

- This manual is for the following readers:
  - the users of the unit
  - the constructor, builder and dealer that mount the unit on the wall
- This manual uses the following signal words for the important information:

### **WARNING**

This content indicates “risk of serious injury or death.”

### **CAUTION**

This content indicates “risk of injury.”

### **NOTICE**

Indicates points that you must observe in order to prevent product failure, damage or malfunction and data loss, as well as to protect the environment.

### **NOTE**

Indicates notes on instructions, restrictions on functions, and additional information that may be helpful.

- The illustrations and screens in this manual are for instructional purposes only.
- The company names and product names in this manual are the trademarks or registered trademarks of their respective companies.

# Contents

<b>IMPORTANT SAFETY INSTRUCTIONS .....</b>	<b>2</b>
<b>PRECAUTIONS .....</b>	<b>4</b>
<b>Supplied items .....</b>	<b>12</b>
<b>Features .....</b>	<b>15</b>
<b>Frequently asked questions.....</b>	<b>16</b>
<b>Part names and functions .....</b>	<b>17</b>
Center unit (front panel).....	17
Center unit (rear panel).....	18
Subwoofer .....	19
<b>Installation .....</b>	<b>20</b>
Installing the unit on a TV stand, etc.....	20
Mounting the unit on a wall.....	20
<b>Connections .....</b>	<b>22</b>
<b>Operations.....</b>	<b>25</b>
Operating the unit by TV's remote control (HDMI control).....	30

<b>Listening to the sound from a Bluetooth device .....</b>	<b>31</b>
<b>Settings .....</b>	<b>34</b>
Configuring the HDMI control function.....	34
Configuring HDMI audio output .....	34
Enabling/disabling the auto power standby function .....	35
Initializing the unit.....	35
<b>Troubleshooting.....</b>	<b>36</b>
<b>Specifications .....</b>	<b>43</b>

# Supplied items

Make sure you have received all of the following items.



Center unit (YAS-CU207)



Remote control

A CR2025 Lithium battery has already been inserted into the remote control.

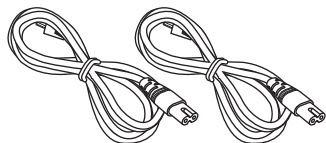

Power cable x 2



Optical digital audio cable



Wireless subwoofer (NS-WSW42)

In this manual, the wireless subwoofer is referred to as "subwoofer".



Mounting template

Use when mounting the center unit on a wall



Owner's Manual (this booklet)

## Preparing the remote control

Remove the battery's insulating strip before attempting to use the remote control.

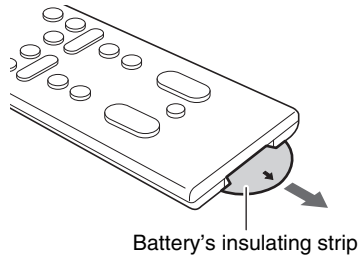

## Operating range of the remote control

Operate the remote control within the range as shown below.

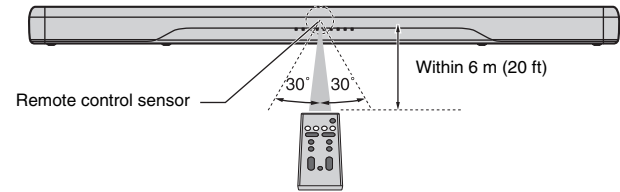

## Replacing the battery in the remote control

Press and hold the release tab in the direction indicated by (A), and slide the battery holder out in the direction indicated by (B).

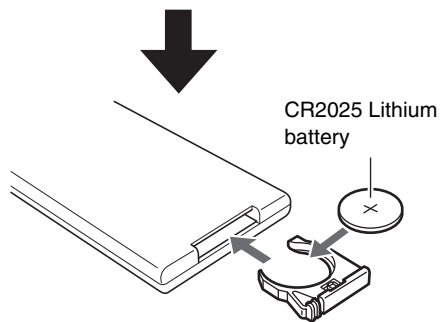
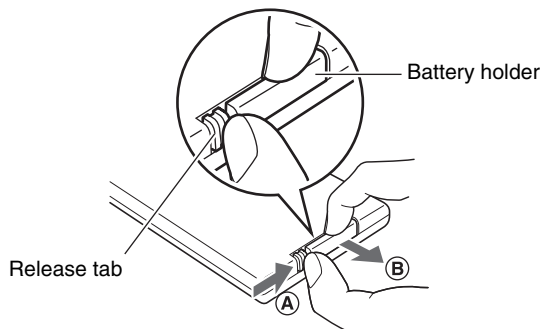

# Features

This front surround system, comprised of the center unit and wireless subwoofer, allows you to enjoy dynamic sound with video played on your home TV.

- **3D surround playback**

Surround sound can be heard not only from horizontal directions, but also from varying heights when DTS Virtual:X is used (p. 27).

- **Wireless subwoofer**

Dynamic sound can be heard by using the dedicated wireless subwoofer.

- **Transmission of 4K high dynamic range (HDR) video supported**

Enjoy high-resolution video from a cable or satellite set top box, or a BD/DVD player. When a TV that supports Audio Return Channel (ARC) is used, this ARC-compatible unit can be connected to the TV via a single HDMI cable (p. 22).

- **HDMI control function**

Link TV and unit functions using the TV's remote control (p. 30).

- **Bluetooth connection**  **Bluetooth®**

Easily play content from a Bluetooth-compatible smartphone, tablet, or computer (p. 31).

Our exclusive Compressed Music Enhancer technology improves sound quality and characteristics, and can be used to enjoy realistic and impressive sound.

- **HOME THEATER CONTROLLER app** 

HOME THEATER CONTROLLER, a free app for smartphones, allows you to easily operate the unit using a smartphone (p. 33).

- **Bass extension**

Boost low bass levels to enjoy more powerful sound (p. 27).

- **Clear voice**

This feature makes speech, such as dialog and narration, clearer (p. 27).

# Frequently asked questions

The following section covers popular functions and frequently asked questions about the unit.

---

**Q1 Can I use the TV's remote control to operate the unit?**

**A1** Yes. When the unit is connected to a TV via HDMI cable, the TV's remote control can be used to operate both the TV and the unit (p. 30).

---

**Q2 Can I improve the clarity of dialogue?**

**A2** Yes. Dialogue in movies, TV news, sports programs, etc., can be made clearer using the "clear voice" function (p. 27).

---

**Q3 Can I use a smartphone to operate the unit? Can I use a smartphone to turn the unit on or off?**

**A3** Yes. The unit can be operated with a smartphone using the free app, HOME THEATER CONTROLLER, installed on the smartphone (p. 33).  
In addition, the Bluetooth standby function can be used to turn on the unit when a Bluetooth connection between the unit and the smartphone is established, and to turn off the unit when that connection is terminated (p. 33).

---

**Q4 Can the brightness of the indicators be adjusted?**

**A4** Yes. Use the DIMMER key on the remote control (p. 29).

---

**Q5 How can surround playback be enabled?**

**A5** Use the SURROUND key on the remote control to select 3D or surround playback (p. 27).

---

**Q6 Can the subwoofer's volume be adjusted?**

**A6** Yes. Use the SUBWOOFER (+/-) keys on the remote control (p. 28).

---



# Part names and functions

## Center unit (front panel)

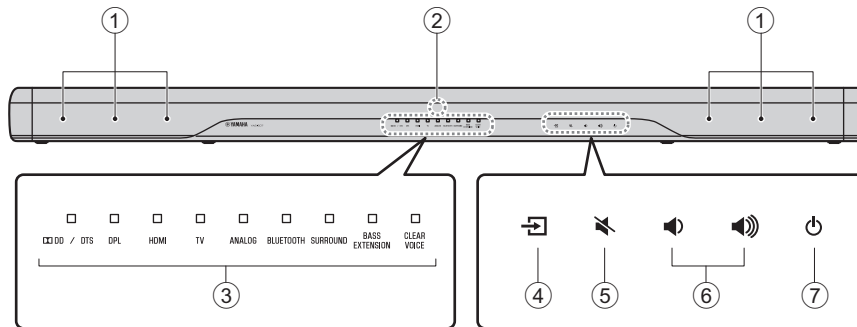

### ① Speakers

### ② Remote control sensors

Receive infrared signals from the remote control of the unit (p. 13).

### ③ Indicators

The indicators on the top panel flash or glow, to show the operation and setting status. In this manual, illustrations of the nine in-line indicators are used for explanation as necessary.

□ : Off      ■ : Glows      ☀ : Flashes

**Example:** When the DPL and SURROUND indicators glow, and the HDMI indicator flashes



### ④ (input)

Select an input source to be played back (p. 26).

### ⑤ (mute)

Mute the audio output. Touch again to unmute (p. 28).

### ⑥ (volume +/-)

Adjust the volume (p. 28).

### ⑦ (power)

Turn on or off the unit (p. 25).

#### **NOTE**

- The unit may automatically turn off when the auto power standby function is enabled (p. 35).

④, ⑤, ⑥, and ⑦ are touch sensors. Touch icons with your finger to control functions.

## Center unit (rear panel)

Illustrations of the rear panel of the center unit used in this manual show the respective positions of jacks with the labels used on the bottom of the center unit itself so that jacks may be easily recognized.

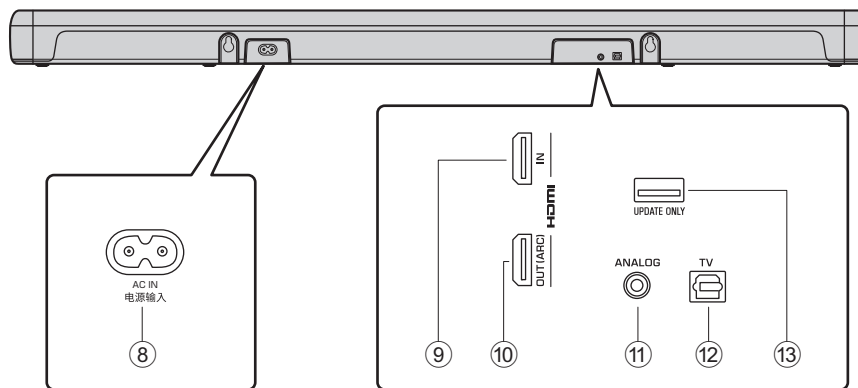

### ⑧ AC IN jack

Connect the power cable of the center unit (p. 24).

### ⑨ HDMI IN jack

For connecting an HDMI-compatible playback device such as a BD/DVD player, a satellite and cable TV tuner, and a game console (p. 22).

### ⑩ HDMI OUT (ARC) jack

For connecting to an HDMI-compatible TV (p. 22).

### ⑪ ANALOG input jack

For connecting to an external device with a 3.5 mm stereo mini plug cable (p. 23).

### ⑫ TV input jack

For connecting to a TV with an optical digital audio cable (p. 22).

### ⑬ UPDATE ONLY jack

Use to update this unit's firmware.

Refer to the instructions supplied with the firmware for details.

# Subwoofer

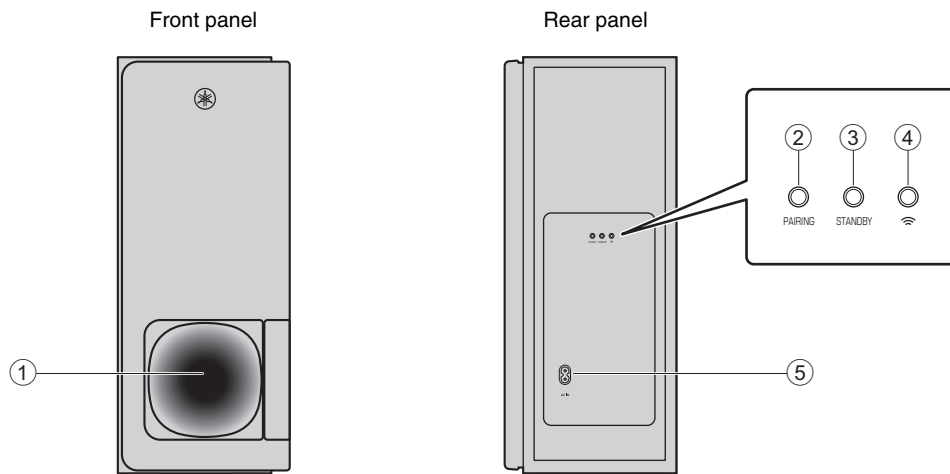

① **Bass reflex port**

② **PAIRING button**

Used to pair the center unit with the subwoofer manually (p. 42).

③ **STANDBY indicator**

Shows subwoofer's status (p. 25).

④ **Wi-Fi indicator**

Glow when the center unit and subwoofer are connected wirelessly.

⑤ **AC IN jack**

Connect the power cord of the subwoofer (p. 24).

# Installation

The center unit can be installed on a TV stand or mounted on a wall.

Position the subwoofer to the left or right of the center unit. Angle the subwoofer slightly toward the center of the room to prevent sound from reflecting off of walls.

## Installing the unit on a TV stand, etc.

Position the unit with the touch panel facing forward.

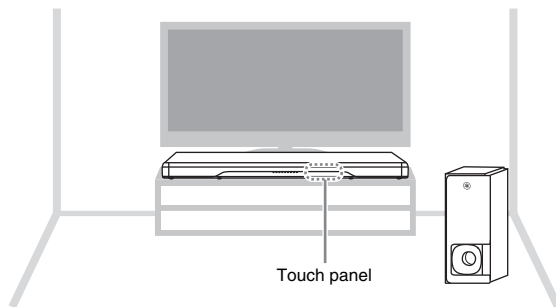

## Mounting the unit on a wall

Refer to “Mount the unit on a wall” (p. 21) for instructions on mounting the unit on a wall so that the touch panel faces forward.

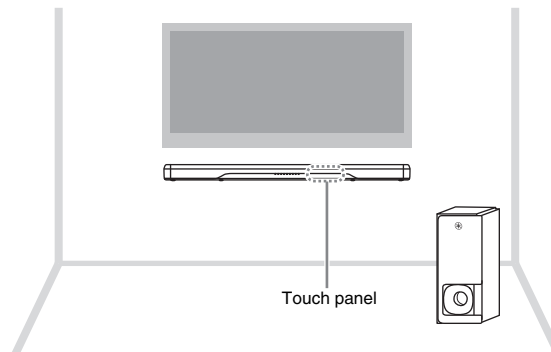

### NOTICE

- Do not stack the center unit and a BD player or other device directly on each other. Doing so may cause a malfunction due to vibrations.
- Avoid touching, and never place any weight or pressure on, the speakers (portion covered with fabric) of the subwoofer. Doing so may damage the speakers.
- The subwoofer can only be used in its upright position. Do not position the subwoofer on its side.
- The subwoofer contains non-magnetic shielding speakers. Do not place magnetically sensitive items (hard disk drive, etc.) near the unit.
- The center unit and subwoofer communicate wirelessly. Do not place objects that block or interfere with wireless signals, such as metallic furniture or devices, between the center unit and the subwoofer as wireless communication may be adversely affected.
- If the subwoofer is covered with a cloth or other object, sound volume will be reduced. Position the subwoofer so that it is not hidden behind heavy fabric, such as a curtain.

## Mount the unit on a wall



### CAUTION

- When mounting the unit on a wall, all installation work must be performed by a qualified contractor or dealer. The customer must never attempt to perform this installation work. Improper or inadequate installation could cause the unit to fall, resulting in personal injury.
- To prevent the unit from falling, attach it to a wall constructed of drywall (plasterboard).
- Make sure you use commercially available screws that can support the weight of the installation (specified in Step 2 on the right). Using clamps other than specified screws, such as short screws, nails, and two-sided tape, may cause the unit to fall.
- Fix the cables in place where they will not become loose. If your foot or hand accidentally gets caught on a loose cable, the unit may fall.
- Do not lean on the unit or apply excessive force to the top of the unit. Doing so may cause the unit to fall.
- Check that the unit is fixed securely after the installation. Yamaha will bear no responsibility for any accidents caused by improper installations.

- 1 Attach the mounting template on a wall and mark for the screw holes.**

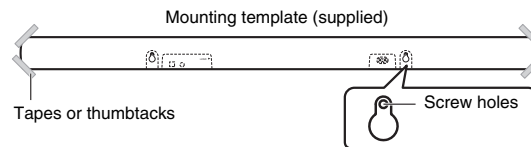

- 2 Remove the mounting template from the wall, then install commercially available screws (as illustrated below) at the points marked on the wall.**

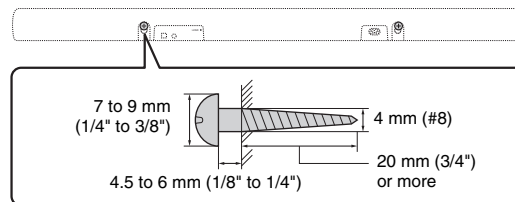

- 3 Hang the unit on the screws.**

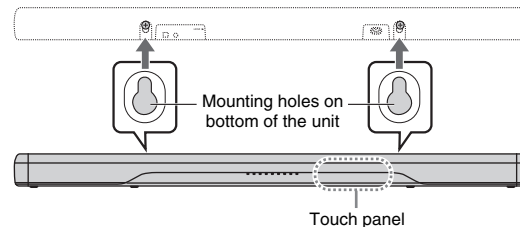

# Connections

## 1 Connecting a TV and set-top box

For the cable connection, follow the procedure below.

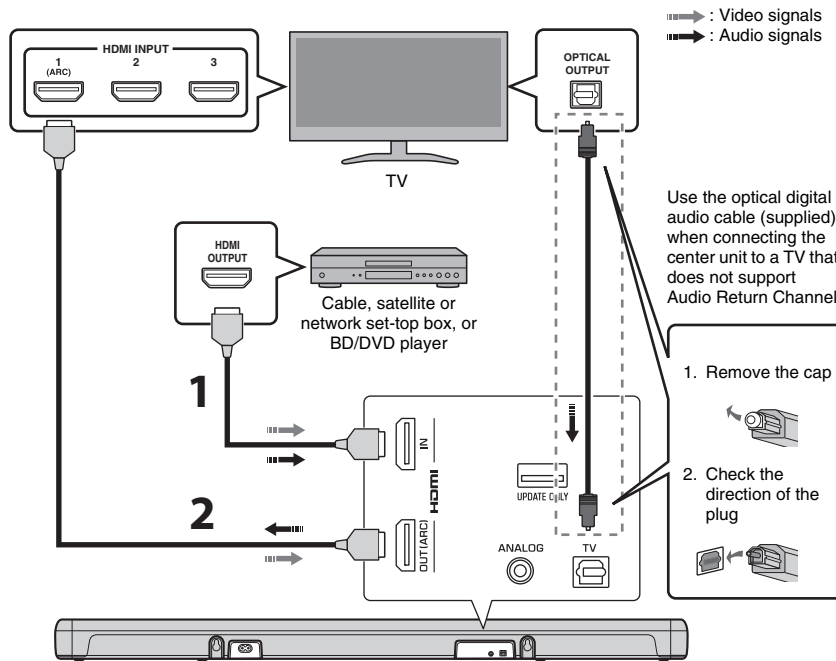

### 1 HDMI cable (optional)

The digital audio/video signals from the set-top box or BD/DVD player are input to this unit.

### 2 HDMI cable (optional)

Digital video from the set-top box or BD/DVD player is displayed on the TV.

#### NOTE

- Use a 19-pin HDMI cable with the HDMI logo printed on it. A cable with a maximum length of 5 m (16 ft) is recommended to prevent degradation of signal quality.
- Use of a flat HDMI cable may make installing the center unit difficult because the cable will be bent by the bottom of the center unit when connected. Confirm the layout and position of jacks on the center unit before choosing an appropriate HDMI cable.
- This unit supports HDCP version 2.2, a copy protection technology. For playback of 4K video, connect the unit to the HDMI input jack (one compatible with HDCP 2.2) on an HDCP 2.2-compliant TV, and to the HDMI output jack on a HDCP 2.2-compliant BD/DVD player.
- Use a high-speed HDMI cable for playback of 3D video content.
- Use a premium HDMI cable for playback of 4K video content.

## NOTE

### Audio Return Channel (ARC) supported TV

- Connect an HDMI cable to the audio return channel supported jack (the jack with "ARC" indicated) on TV.
- Once the HDMI control function has been activated, video and audio content from playback devices can be output from the TV even when this unit is off (HDMI signal pass-through).
- Enable the HDMI control function of this unit to activate the Audio Return Channel (ARC) (p. 34).

### What is Audio Return Channel (ARC)?

In order for the unit to play audio from a TV, the TV must usually be connected to the unit via an audio cable as well as an HDMI cable. If, however, the TV supports Audio Return Channel (ARC), TV audio signals can be input to the unit via the HDMI cable that outputs video signals from the unit to the TV.

## 2 Connecting a game console via the analog jack

Connect an external device, such as a game console or TV that does not have an optical digital audio output, to the ANALOG input jack of the center unit.

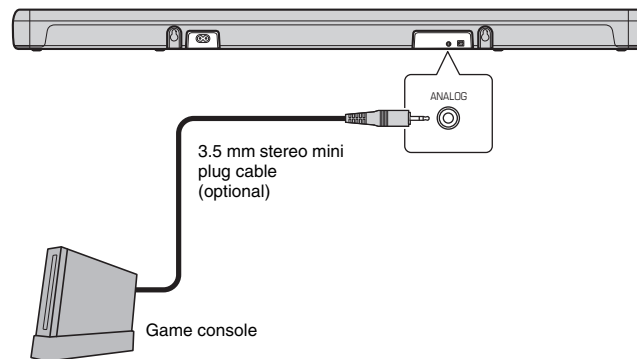

### CAUTION

- If volume can be adjusted on the device connected to the unit's ANALOG input jack, set that device's volume to the same level as that of other devices connected to the unit's HDMI jacks to prevent volume from being louder than expected.

### 3 Connecting the power cable

After all connections are complete, connect the supplied power cables to the AC IN jack on the center unit and subwoofer respectively, and plug the power cables into an AC wall outlet.

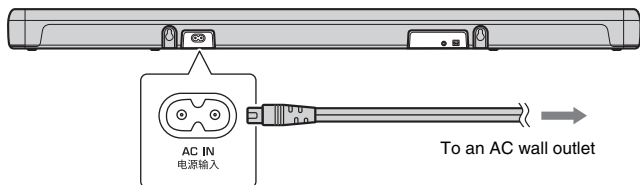

#### Center unit

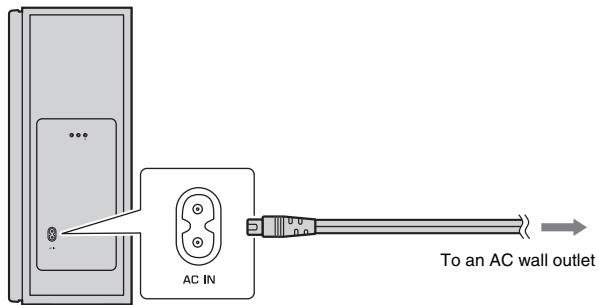

#### Subwoofer



### 4 Turning on the unit

Press the  (power) key on the remote control or touch  on the center unit. The unit turns on and the center unit and subwoofer are automatically connected via wireless connection. Once the connection has been successfully established, the  indicator on the subwoofer's rear panel glows, and the unit is ready for playback.

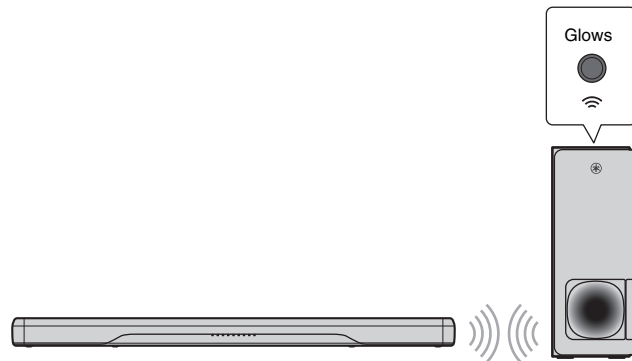

#### NOTE

- If the  indicator on the subwoofer does not glow properly the first time the unit is turned on, pair the center unit and subwoofer manually (p. 42).



# Operations

## Remote control signal transmitter

Transmits infrared signals.

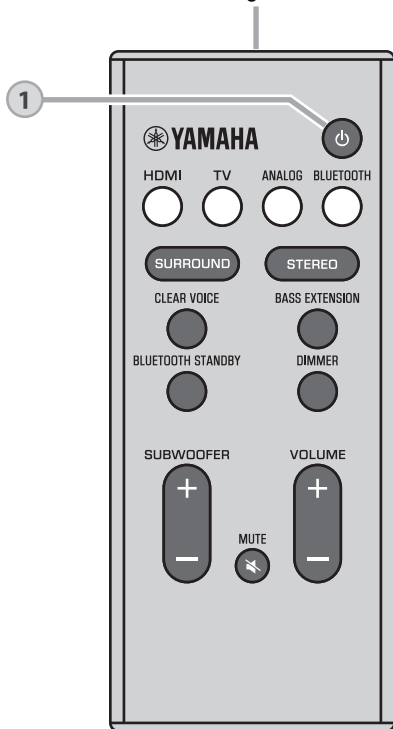

1

## ⏻ (power) key

Turns on or off the unit.

### Center unit

#### Turned on

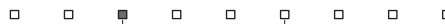

The indicator for the last input source selected glows.

#### Turned off (Bluetooth standby function enabled, p. 33)



### Subwoofer

#### Turned on



#### Turned off



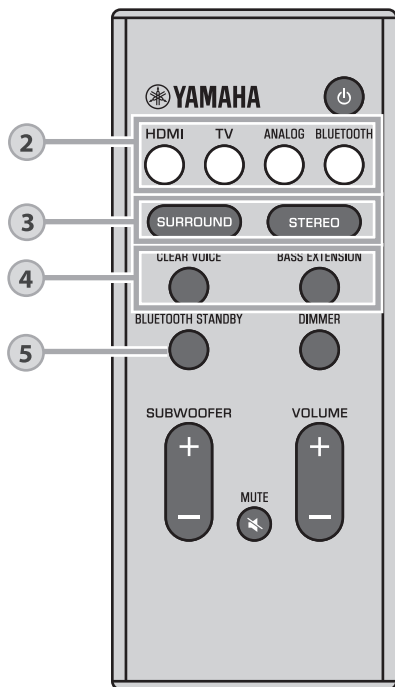

## 2

### Input keys

Select an input source to be played back.

**HDMI** .....Sound from a device connected to the HDMI IN jack

**TV** .....TV audio or sound from a device connected to the unit's TV input jack

**ANALOG** .....Sound from a device connected to the ANALOG input jack

**BLUETOOTH** ....Sound from a Bluetooth connected device (p. 31)

The indicator for the selected input source glows.

(Example: when TV is selected)

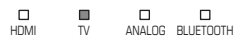

#### **NOTE**

- To play sound from the device connected to the TV or to watch video from the device, set the TV's input source to the device.



### 3

## SURROUND and STEREO keys

Switch between surround and stereo (2-channel) playback.

### SURROUND key

The unit switches between 3D surround playback and surround playback each time the SURROUND key is pressed. When 3D surround is selected, DTS Virtual:X makes it possible to hear sound not only from horizontal directions, but also from varying heights.

-  Glows blue (3D surround playback)
-  Glows green (surround playback)

### STEREO key

Switch to stereo (2-channel) playback.

-  Off

### NOTE

- The DPL indicator glows when 2-channel stereo signal is played in surround.

  
DPL  
Glows  
(Dolby ProLogic II)



- The TV Program, Movie, Music, Sports, or Game surround mode can be selected using the HOME THEATER CONTROLLER app (p. 33) installed on a smartphone that supports the Bluetooth function.

### 4

## CLEAR VOICE key



Enable/disable the clear voice function.

When this function is enabled, human voices such as lines in movies and TV shows, or news and sport commentary, are played clearly.

-  Glows (enabled)
-  Off (disabled)

## BASS EXTENSION key

Enable/disable the bass extension function. When this function is enabled, you can enjoy more powerful sound.

-  Glows (enabled)
-  Off (disabled)

### 5

## BLUETOOTH STANDBY key

Hold down the key for more than 3 seconds to enable/disable the Bluetooth standby function (p. 33).

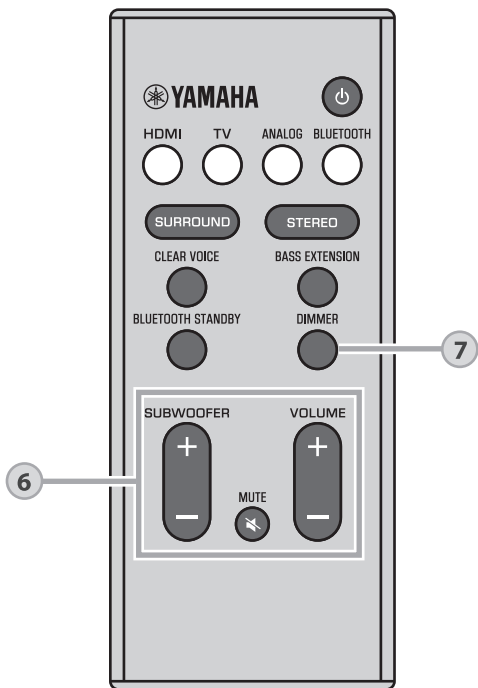

## 6

### SUBWOOFER (+/-) keys

Adjust the volume of the subwoofer.



Volume down (-) ← → Volume up (+)

#### NOTE

- The SUBWOOFER (-) key is also used when pairing the center unit and subwoofer manually.

### MUTE key

Mute the audio output. Press the key again to unmute.



Flash (on mute)

### VOLUME (+/-) keys

Adjust the volume of the unit.



Volume down (-) ← → Volume up (+)

# 7

## DIMMER key

Change the brightness of the indicators. Each time the key is pressed, the brightness of the indicators changes as follows.

Dim (default setting) → Off → Bright



Indicators glow brightly just after operation and change to the specified brightness after a few seconds.

## Decoder indicator

The unit supports the following audio signals. The color of the indicator identifies the type of audio input signal.

 Green (Dolby Digital), Red (DTS)

 Off (PCM/analog signal/no input signal)

## Operating the unit by TV's remote control (HDMI control)

The HDMI control function (link function) coordinates operation of a TV and the unit so that the unit can be operated using the TV's remote control.

When a TV is connected to the center unit with an HDMI cable (p. 22), the TV's remote control can be used to perform the following operations.

### Coordinated functions via the TV remote control

Remote control of TV (Example)

#### 1. Turn on/off

Both the TV and this unit turn on/off at the same time.

#### 2. Switch input sources

- The unit's input source switches accordingly when the TV's input source is switched.

Examples

- When a TV program is selected on the TV, the unit's audio input source is switched to the HDMI OUT (ARC) jack using the ARC function or TV jack.
- When a BD/DVD player is connected to the HDMI IN jack on the unit, the unit's input source switches to HDMI when the BD/DVD player is selected with the TV's remote control.
- The input source can be switched while the unit is off.

#### 3. Switch the audio output device (TV or this unit (amplifier))

#### 4. Adjust volume

This unit's volume can be adjusted when the TV's audio output is set to this unit (amplifier).

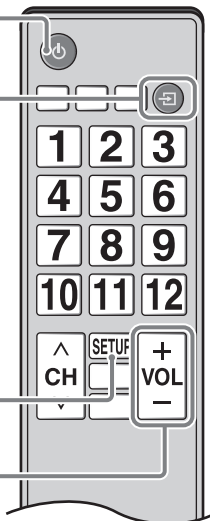

### NOTE

- If you are unable to operate the unit with your TV's remote control, configure the HDMI control function of your TV and the unit. See page 34 for more information.
- Even if your TV supports the HDMI control function, some functions may not be available. For details, refer to documentation supplied with your TV.
- We suggest using devices (TV, BD/DVD player, etc.) from the same manufacturer.

# Listening to the sound from a Bluetooth device

Audio from a Bluetooth device, such as a smartphone or a digital music player, can be played over a wireless connection.

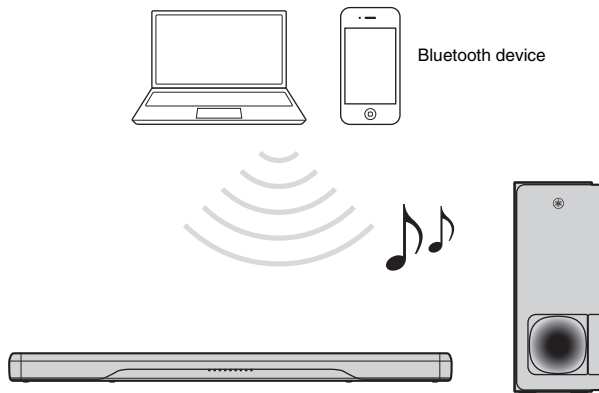

## **NOTE**

- Adjust the volume level of the Bluetooth device as required.
- Perform Bluetooth connection with the device and unit within 10 m (33 ft) of each other.
- See documentation supplied with your Bluetooth device for more information.

- 1 Press the BLUETOOTH key on the unit's remote control to select Bluetooth as the input source.**  
The BLUETOOTH indicator on the unit flashes.





If a Bluetooth device has been connected before, the unit will connect to the last connected device when the BLUETOOTH key is pressed. Terminate this connection to connect a new device.

- 2 Enable the Bluetooth function on the Bluetooth device.**

### 3 Select “YAS-207 Yamaha” in the Bluetooth device list on the device.

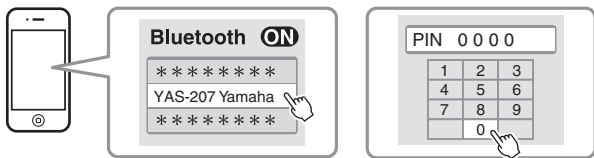
If a passkey (PIN) is required, enter the number “0000”.



When the connection is established, the  indicator or a completion message is displayed on the Bluetooth device, and the BLUETOOTH indicator on the unit glows.



### 4 Play back a song on the Bluetooth device.

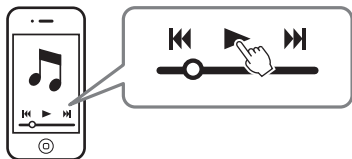

## Terminating Bluetooth connection

Bluetooth connection is terminated in the following cases.

- The Bluetooth function is turned off on the compatible device.
- The BLUETOOTH key on the unit's remote control is pressed for more than 3 seconds.
- The unit is turned off.

When the Bluetooth connection is terminated with the unit turned on, the BLUETOOTH indicator flashes and the unit enters the connection wait status.



## Using the Bluetooth standby function

The Bluetooth standby function allows you to turn on or off the unit automatically, linked with the operation of the Bluetooth device.

### 1 With the unit turned on, hold down the **BLUETOOTH STANDBY** key on the unit's remote control for more than 3 seconds.

Holding down the **BLUETOOTH STANDBY** key for 3 seconds switches function status between enabled and disabled.

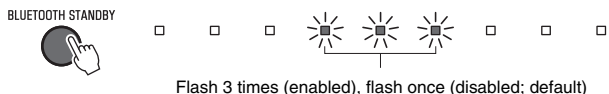

Enabling the Bluetooth standby function allows the unit to be turned on or off using a Bluetooth device.

#### **Power on interlock function (when the unit is turned off)**

When Bluetooth connection is made on the device, the unit will turn on and will be ready to play back sound from the device.

#### **Power off interlock function (when the unit is turned on)**

The unit will be turned off when Bluetooth connection is terminated on a Bluetooth device. (Only when **BLUETOOTH** is selected as the input source.)

## Using the HOME THEATER CONTROLLER app

When the free HOME THEATER CONTROLLER app is installed on a Bluetooth-compatible smartphone or other device, various operations (basic operation of the unit, selection of a surround mode, adjustment of sound settings, etc.) can be easily performed using the Bluetooth device.

### **NOTE**

- To use the app, connect the unit and a Bluetooth device via Bluetooth connection.
- If the Bluetooth standby function is enabled, the unit will be turned on with the Bluetooth device.

For details on the “HOME THEATER CONTROLLER” app, see the product information on our website.

# Settings

## Configuring the HDMI control function

Follow the procedure below to enable or disable the unit's HDMI control function. This function is enabled by default.

- 1 Turn off the unit.
- 2 Hold down the HDMI key on the unit's remote control for more than 3 seconds.

The HDMI control function is enabled or disabled, and the unit turns on. The indicator shows HDMI control function status for several seconds immediately after the unit is turned on.

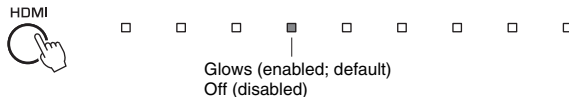

### NOTE

- Enable the HDMI control function when connecting a TV that supports Audio Return Channel (ARC) (p. 23), or when using HDMI signal pass-through (p. 23).

#### If the unit cannot be operated with the TV's remote control

Confirm the settings are properly configured as described below.

- The HDMI control function of this unit is enabled.
- The HDMI control function is enabled on the TV.

#### Examples of TV settings

- From the setup menu on your TV, select "Link setting" → "HDMI control setting", then set a setting such as "HDMI control function" to "ON".
- Set audio output to any option other than TV.

If the unit cannot be operated with the TV's remote control even after the settings described above have been applied correctly:

- Turn off this unit and the TV, and then turn them back on again.
- Disconnect the power cables of the center unit, subwoofer, and external devices connected to the center unit via HDMI cable. Plug them in again after about 30 seconds.

## Configuring HDMI audio output

Specify whether HDMI audio input signal will be played from the unit or the TV. This setting can only be configured when the HDMI control function is disabled.

<b>The unit (default)</b>	Play HDMI audio input signal from the unit.
<b>TV</b>	Play HDMI audio input signal from the TV connected to the HDMI OUT (ARC) jack on the unit. The unit cannot be used to adjust volume. Use TV controls to adjust volume.

- 1 Turn off the unit.
- 2 Hold down the SURROUND key on the remote control for more than 3 seconds.

HDMI audio output switches between this unit and the TV, or vice versa, and the unit turns on. The indicator shows HDMI audio output status for several seconds immediately after the unit is turned on.

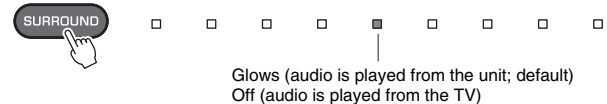

### NOTE

- To configure HDMI audio output with the HDMI control function enabled, select the audio output device configured for the TV connected to this unit.
- HDMI video signals input to the HDMI IN jack of this unit are always output from the HDMI OUT (ARC) jack of this unit.

## Enabling/disabling the auto power standby function

Enabling the auto power standby function prevents the unit from remaining on when not in use. When the auto power standby function is enabled, the unit automatically turns off in any of the following situations.

- No operations for 8 hours
- No audio input and no operations for 20 minutes when BLUETOOTH or HDMI is selected as the input source.

### 1 Turn off the unit.

### 2 Touch and hold and touch on the center unit.

The auto power standby function is enabled or disabled, and the unit turns on. The indicator shows auto power standby function status for several seconds immediately after the unit is turned on.



#### **NOTE**

- The default setting for the auto power function varies by country or region.
  - U.K., Europe, Central and South America, and Asia models: enabled
  - Other models: disabled

## Initializing the unit

Follow the procedure below to initialize the unit.

### 1 Turn off the unit.

### 2 Touch and hold and on the center unit until all indicators flash.

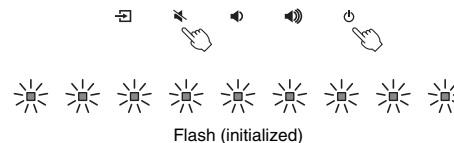



# Troubleshooting

Refer to the table below when the unit does not function properly. If the problem you are experiencing is not listed below or if the instructions below do not help, turn off the unit, disconnect the power cables of the center unit and subwoofer, and contact the nearest authorized Yamaha dealer or service center.

First, check the following:

- ① **The power cables of the center unit, subwoofer, TV and playback devices (such as BD/DVD players) are connected to AC wall outlet securely.**
- ② **The center unit, subwoofer, TV and playback devices (such as BD/DVD players) are turned on.**
- ③ **The connectors of each cable are securely inserted into jacks on each device.**



## Power and system

Problem	Cause	Remedy
<b>The power turns off suddenly.</b>	When the auto power standby function is enabled, the unit automatically turns off in any of the following situations: - No operations have been performed for 8 hours - BLUETOOTH or HDMI is selected as the input source, but no audio has been input to the unit or no operations have been performed with the unit for more than 20 minutes.	Turn on the unit again. If the auto power standby function is not used, disable the function (p. 35).
	The protection circuitry has been activated. (The  DD / DTS indicator on the center unit flashes.)	After confirming that all connections are made properly, turn on the unit again. If the power still turns off frequently, unplug the power cable from the AC wall outlet and contact the nearest authorized Yamaha dealer or service center.
	The Bluetooth connection was terminated by a Bluetooth device with the unit's Bluetooth standby function enabled.	Disable the Bluetooth standby function (p. 33).
<b>The power cannot be turned on.</b>	The protection circuitry has been activated three times consecutively. (If you try to turn on the power in this condition, the  DD / DTS indicator on the center unit will flash.)	To protect the product, the power cannot be turned on. Unplug the power cable from the AC wall outlet and contact the nearest authorized Yamaha dealer or service center.

Problem	Cause	Remedy
<b>All indicators go out although the unit is turned on (it may seem that the unit is turned off).</b>	The unit is configured so that indicators do not glow or flash unless the unit is being operated.	Use the DIMMER key to select the desired brightness (p. 29).
<b>The unit does not function correctly.</b>	The internal microcomputer is frozen, due to an external electric shock (such as lightning or excessive static electricity) or to a drop in the power supply voltage.	Unplug the power cable from the AC wall outlet and plug it again.
<b>The unit turns on by itself.</b>	Another Bluetooth device is being operated nearby.	Terminate Bluetooth connection with the unit (p. 32).
<b>The TV's 3D glasses do not work.</b>	The unit is blocking the TV's 3D glasses transmitter.	Confirm the position of the TV's 3D glasses transmitter, and position the unit so that it does not obstruct the transmitter.
<b>The unit cannot be operated with the HOME THEATER CONTROLLER app. (The screen on the Bluetooth device will not exit the app's demo mode.)</b>	The Bluetooth device on which the app has been installed is not connected to the unit.	Establish a Bluetooth connection between the Bluetooth device and the unit to use the app (p. 31).

## Audio

Problem	Cause	Remedy
<b>No sound.</b>	Another input source is selected.	Select an appropriate input source (p. 26).
	The mute function is activated.	Cancel the mute function (p. 28).
	The volume is too low.	Turn up the volume (p. 28).
	The power cable of the center unit is not connected properly.	Make sure that the power cable of the center unit is connected to an AC wall outlet securely (p. 24).
	Input jacks on a playback device are connected.	Connect the input jack on the center unit and the output jack on the playback device.
	Signals that the unit cannot play back are being input.	Change the digital audio output setting on the playback device to PCM, Dolby Digital or DTS.
	The center unit is configured so that HDMI audio input signals are output from the TV.	Configure the unit so that HDMI audio input signals are output from the unit (p. 34)
	The HDMI control function is disabled.	When connecting a TV that supports ARC (Audio Return Channel) to the unit using an HDMI cable only, enable the HDMI control function (p. 34). To output audio signals from this unit with the HDMI control function disabled, connect the TV's audio output jack to the center unit's TV input jack (optical digital) via the optical digital audio cable (p. 22).
Sound from an HDMI control-enabled TV is set for output from the TV's built-in speakers.	Use the TV's HDMI settings to set audio output to any option other than the TV's built-in speakers.	
<b>No sound is coming from the subwoofer.</b>	The subwoofer is not connected to an AC wall outlet.	Plug in the power cable of the subwoofer to an AC wall outlet (p. 24).
	The protection circuitry in the subwoofer has been activated.	To protect the product, the power of the subwoofer cannot be turned on. Unplug the power cable from the AC wall outlet and contact the nearest authorized Yamaha dealer or service center.

Problem	Cause	Remedy
<b>No sound is coming from the subwoofer. (The  indicator on the subwoofer flashes or the STANDBY indicator on the subwoofer glows.)</b>	The center unit and subwoofer are not connected due to a bad wireless communication status.	Move the subwoofer closer to the center unit. If the issue is not resolved, move the subwoofer to a location that supports better communication (one in which the  indicator glows).
		If the communication between the center unit and subwoofer is obstructed by a metallic object or another object, change the position of the center unit and subwoofer or change the installation location of the subwoofer.
		If there is a device (microwave oven, wireless LAN, etc.) that emits radio frequency signals, move the center unit and subwoofer away from the device.
<b>Though the  indicator on the subwoofer glows, little or no sound is coming from the subwoofer.</b>	The center unit and subwoofer are not paired.	Pair the center unit and subwoofer manually (p. 42). If a wireless connection is not established, the unit may be malfunctioning. Unplug the power cables from the AC wall outlets and contact the nearest authorized Yamaha dealer or service center.
	The volume is too low.	Turn up the volume of the subwoofer (p. 28).
	The front side of the subwoofer is blocked.	Clear the area around the front side and the bass reflex port of the subwoofer.
<b>The volume decreases when the unit is turned on.</b>	The playback source does not contain low-frequency signals.	Play back a sound source containing low-frequency signals, and confirm that the sound is output from the subwoofer.
	The automatic volume adjustment function is activated. To prevent excessive loudness, the unit automatically controls its volume within a certain level when the unit is turned on.	Turn up the volume as required (p. 28).

<b>Problem</b>	<b>Cause</b>	<b>Remedy</b>
<b>No surround effect.</b>	Stereo playback is selected.	Select surround playback or 3D surround playback (p. 27).
	The volume is too low.	Turn up the volume (p. 28).
	The TV or playback device is set to output 2 channel audio (such as PCM) only.	Change the digital audio output setting on the TV or playback device to BitStream.
	Sound is also heard from the TV built-in speakers.	Set the TV volume to minimum (p. 30).
	The listening position is too close to the unit.	The listening position should be at some distance from the unit.
<b>Noise is heard.</b>	The unit is too close to another digital or high-frequency device.	Move those devices away from the unit.
<b>Video is not displayed on TV screen.</b>	The HDMI cable is not securely connected.	Connect the HDMI cable properly (p. 22).
<b>When the unit is turned off, video and/or audio from a playback device are not output to the TV.</b>	The HDMI control function is disabled.	Enable the HDMI control function (p. 34).

## Remote control

<b>Problem</b>	<b>Cause</b>	<b>Remedy</b>
<b>The unit cannot be operated using the remote control.</b>	The unit is out of the operating range.	Use the remote control within the operating range (p. 13).
	The batteries are weak.	Replace with new batteries (p. 14).
	The remote control sensor of the center unit is exposed to direct sunlight or strong lighting.	Adjust the lighting angle, or reposition the center unit.
<b>The TV cannot be operated using the TV's remote control.</b>	The center unit is blocking the TV's remote control sensor.	Position the center unit so that it does not obstruct the TV's remote control sensor.



## Bluetooth

Problem	Cause	Remedy
<b>The unit cannot be connected to a Bluetooth device.</b>	Bluetooth is not selected as the input source.	Select Bluetooth as the input source (p. 31).
	The unit is connected to a different Bluetooth device.	Unpair the Bluetooth device that is currently connected, and pair with the desired Bluetooth device.
	The unit is too far away from the Bluetooth device.	Move the Bluetooth device closer to this unit.
	A device emitting electromagnetic waves (such as a microwave oven, a wireless device and so on) may be located nearby.	Do not use this unit near devices that emit electromagnetic waves.
	The Bluetooth device you are using may not support the A2DP protocol.	Use a Bluetooth device that supports the A2DP protocol.
	The connection profile registered in the Bluetooth device may not be functioning correctly for some reason.	Delete the connection profile in the Bluetooth device, and then connect the Bluetooth device to this unit.
	The passkey on the Bluetooth adapter or other device may be set to a code besides "0000".	Use a Bluetooth device on which the passkey is set to "0000".
<b>No sound can be heard, or the sound cuts off intermittently.</b>	The volume on the Bluetooth device may be too low.	Raise the volume on the Bluetooth device.
	Bluetooth is not selected as the input source.	Select Bluetooth as the input source (p. 31).
	Playback on the device has not been performed.	Perform playback on the device.
	The sound output on the Bluetooth device may not be set to this unit.	Select this unit as the output destination on the Bluetooth device.
	The connection to the Bluetooth device was cut off.	Connect with the Bluetooth device one more time.
	The unit may be too far away from the Bluetooth device.	Move the Bluetooth device near this unit.
	A device emitting electromagnetic waves (such as a microwave oven, a wireless device and so on) may be located nearby.	Do not use this unit near devices that emit electromagnetic waves.

## Pairing the center unit and subwoofer manually

- 1** Turn off the unit.
- 2** Press and hold the **SUBWOOFER (-)** key on the remote control for more than 3 seconds.

The DPL indicator on the center unit flashes.



- 3** Within 30 seconds, press and hold the **PAIRING** button on the rear panel of the subwoofer for more than 3 seconds.

Once the center unit and subwoofer have been paired and a wireless connection established, the  indicator will glow, and the center unit and subwoofer turn on.

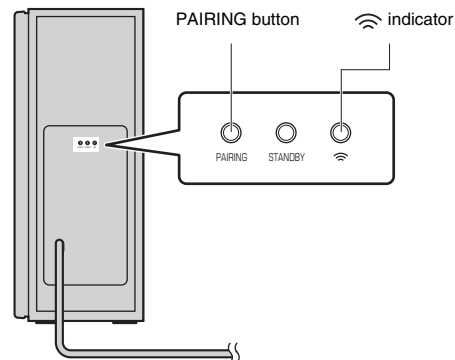

If the  indicator on the subwoofer does not glow after following the procedure described here, refer to “Troubleshooting” (p. 36).

### **NOTE**

- Pairing is the process of establishing a wireless connection between the center unit and subwoofer.

# Specifications

Item		Center unit (YAS-CU207)	Subwoofer (NS-WSW42)
<b>Amplifier Section</b>	<b>Maximum Rated Output Power</b>	Front L/R 50 W x 2 ch	100 W
<b>Speaker Section</b>	<b>Type</b>	Front L/R: Acoustic suspension type	Bass reflex type
	<b>Driver</b>	Front L/R: 46 mm (1-3/4") cone magnetic shielding type x 4 Tweeter: 25 mm (1") dome magnetic shielding type x 2	16 cm (6-1/4") cone non-magnetic shielding type x 1
	<b>Frequency Response</b>	Front L/R: 180 Hz to 23 kHz Tweeter: 7 kHz to 23 kHz	40 Hz to 180 Hz
	<b>Impedance</b>	Front L/R: 4 Ω (8 Ω x 2) Tweeter: 4 Ω	2 Ω
<b>Decoder</b>	<b>Supported audio signal (TV, BD/DVD)</b>	PCM (up to 5.1ch) Dolby Digital (up to 5.1ch) DTS Digital Surround (up to 5.1ch)	—
<b>Input Jacks</b>	<b>HDMI</b>	1 (HDMI IN)	—
	<b>Digital (Optical)</b>	1 (TV)	—
	<b>Analog (3.5 mm stereo mini)</b>	1 (ANALOG)	—
<b>Output Jack</b>	<b>HDMI</b>	1 (HDMI OUT (ARC))	—
<b>Other Jacks</b>	<b>UPDATE ONLY</b>	1	—
<b>Wireless subwoofer</b>	<b>Radio frequency band</b>	2.4 GHz	
	<b>Radio frequency (Operational frequency)</b>	2402 MHz to 2480 MHz	
	<b>Maximum output power (EIRP)</b>	20 dBm (100 mW)	
	<b>Transmission range</b>	10 m ([33 ft] without interference)	

Item	Center unit (YAS-CU207)	Subwoofer (NS-WSW42)		
<b>Bluetooth</b>	<b>Bluetooth version</b>	Ver. 4.1	—	
	<b>Supported profiles</b>	A2DP, SPP	—	
	<b>Supported codecs</b>	SBC, MPEG4 ACC	—	
	<b>Radio frequency (Operational frequency)</b>	2402 MHz to 2480 MHz	—	
	<b>Maximum output power (EIRP)</b>	20 dBm (100 mW)	—	
	<b>Bluetooth class</b>	Bluetooth Class 2	—	
	<b>Range (line-of-sight)</b>	Approx. 10 m (33 ft)	—	
	<b>Supported content protection method</b>	SCMS-T	—	
<b>General</b>	<b>Power Supply</b>	U.S.A. and Canada models: AC 120 V, 60 Hz U.K., Europe, Central and South America, and Asia models: AC110 - 240 V, 50/60Hz Taiwan model: AC 110 V, 60 Hz Korea model: AC 220 V, 60 Hz China model: AC 220 V, 50 Hz Australia model: AC 240 V, 50 Hz		
	<b>Power Consumption</b>	30 W	19 W	
	<b>Standby Power Consumption</b>	U.S.A., Canada and Taiwan models HDMI Control Off, Bluetooth Standby Off: 0.3 W HDMI Control On, Bluetooth Standby Off: 0.6 W HDMI Control Off, Bluetooth Standby On: 0.3 W HDMI Control On, Bluetooth Standby On: 0.8 W  U.K. and Europe models, and other models HDMI Control Off, Bluetooth Standby Off: 0.4 W HDMI Control On, Bluetooth Standby Off: 0.9 W HDMI Control Off, Bluetooth Standby On: 0.5 W HDMI Control On, Bluetooth Standby On: 0.9 W	U.S.A., Canada, and Taiwan models: 0.5 W U.K. and Europe models, and other models: 0.6 W	
	<b>Dimensions (W x H x D)</b>	930 x 60 x 108 mm 36-5/8" x 2-3/8" x 4-1/4"	180 x 437 x 401 mm 7-1/8" x 17-1/4" x 15-3/4"	
	<b>Weight</b>	2.7 kg (6.0 lbs)	7.9 kg (17.4 lbs)	

## HDMI signal

### • Audio signals

Audio signal types	Audio signal formats	Compatible media
2ch Linear PCM	2ch, 32–192 kHz, 16/20/24 bit	CD, DVD-Video, DVD-Audio, etc.
Multi-ch Linear PCM	6ch, 32–192 kHz, 16/20/24 bit	DVD-Audio, Blu-ray disc, HD DVD, etc.
Bitstream	Dolby Digital, DTS	DVD-Video, etc.

### **NOTE**

- Refer to documentation supplied with the playback device, and set the device appropriately.
- When CPPM copy-protected DVD-Audio is played back, video and audio signals may not be output depending on the type of the DVD player.
- This unit is not compatible with HDCP-incompatible HDMI or DVI devices. Refer to documentation supplied with the HDMI or DVI device for HDCP compatibility.
- To decode audio bitstream signals on this unit, set the input source device appropriately so that the device outputs the bitstream audio signals directly (does not decode the bitstream signals on the device). Refer to documentation supplied with the device for details.

### • Video signals

This unit is compatible with the following video signals.

- Deep Color
- x.v.Color
- 3D video signal
- High Dynamic Range (HDR) video

### **This unit is compatible with the following resolutions.**

- VGA
  - 720p/60 Hz, 50 Hz
- 480i/60 Hz
  - 1080i/60 Hz, 50 Hz
- 480p/60 Hz
  - 1080p/60 Hz, 50 Hz, 30 Hz, 25 Hz, 24 Hz
- 576i/50 Hz
  - 4K/60 Hz, 50 Hz, 30 Hz, 25 Hz, 24 Hz
- 576p/50 Hz

### **NOTE**

- The resolution of transmitted video signal varies according to specifications of the TV connected to this unit.

## Digital audio signal

### • Optical

Audio signal types	Audio signal formats	Compatible media
2ch Linear PCM	2ch, 32–96 kHz, 16/20/24 bit	CD, DVD-Video, DVD-Audio, etc.
Bitstream	Dolby Digital, DTS	DVD-Video, etc.

### • HDMI (ARC)

Audio signal types	Audio signal formats	Compatible media
2ch Linear PCM	2ch, 32–96 kHz, 16/20/24 bit	TV
Bitstream	Dolby Digital, DTS	TV

The contents of this manual apply to the latest specifications as of the publishing date.

To obtain the latest manual, access the Yamaha website then download the manual file.

**Important Notice: Guarantee Information for customers in EEA\* and Switzerland**

English

For detailed guarantee information about this Yamaha product, and Pan-EEA\* and Switzerland warranty service, please either visit the website address below (Printable file is available at our website) or contact the Yamaha representative office for your country.

\* EEA: European Economic Area

<http://europe.yamaha.com/warranty/>

Yamaha Global Site  
<http://www.yamaha.com/>

Yamaha Downloads  
<http://download.yamaha.com/>

Manual Development Group  
© 2017 Yamaha Corporation

Published 10/2017 KS-B0  
Printed in China

**AV16-0010**

YAMAHA CORPORATION

10-1 Nakazawa-cho, Naka-ku, Hamamatsu, 430-8650 Japan